



Homematic IP

The smart home system from the European market leader*

Homematic IP offers a smart solution for automating applications in daily use to suit your specific needs.

On the following pages, you'll find a selection of products in the categories:

- Central control units & gateways
- Climate control
- Security & alarms
- Access
- Light & shade
- Weather & environment

* Smart Homes and Home Automation study (2022).
Berg Insight on whole-home systems.

The smart home that meets your needs

Homematic IP, the smart home system from the European market leader* eQ-3, offers a customer-friendly solution for automating applications in daily use to suit individual needs. It is the perfect answer for everyone from house owners to tenants in flats. And, above all, it is easy to use – without compromising on function or security.

Homematic IP devices can be easily installed, configured and operated. Even if a customer starts small, thanks to the open platform, the solution can be flexibly expanded at any time – and with products from other product families, too. This is why Homematic IP is the ideal entry into the world of smart home technology.

The key to sustainable success is satisfying customer expectations

SAFETY AND SECURITY:

Homematic IP is the only smart home system whose protocol, IT and data security has been certified by VDE.



ROBUSTNESS AND RELIABILITY:

The robust and reliable Homematic IP radio protocol uses a frequency of 868 MHz, so interference from WLAN, Bluetooth and other radio standards in the 2.4 GHz range is eliminated.

OPEN SYSTEM:

Homematic IP is also compatible with many devices and services from other manufacturers. This offers you endless possibilities and functions for your smart home. The Cloud API and CCU software is also freely available and free of charge.

DATA PROTECTION:

When operated via the Homematic IP access point, the Homematic IP cloud service, which runs exclusively on German servers, manages the configuration of the individual devices. The cloud service is therefore subject to both European and German data protection guidelines.

COSTS + TRANSPARENCY:

Homematic IP provides the app and the Homematic IP Cloud, with all their features, free of charge.

FAIL-SAFE:

Direct communication between the devices ensures a high level of reliability and very low latencies. This means that the basic functions (e.g. execution of heating, time and shading profiles as well as local security alarms) work offline at all times.

FUTURE-PROOF:

The Internet of things is a reality with Homematic IP – each device has its own IP address according to the latest Internet standard, IPv6, to ensure you are well equipped for the future.

SIMPLICITY:

The free Homematic IP app guides you step-by-step through the setup, the addition of all your Homematic IP devices and the subsequent individual configuration and combination options.

FLEXIBILITY:

Its wide range of wireless and battery-powered devices makes Homematic IP the ideal retrofit solution. Since these products can be removed without trace at any time, it makes a smart home equally accessible to both owners and tenants alike.

An overview of Homematic IP

The constantly growing Homematic IP range includes devices for climate control, security, light and shade, and access and weather applications, as well as numerous accessories. So Homematic IP not only offers increased safety and security in your home, but also added convenience in your daily life. The entire solution can be intuitively set up via a free smartphone app and conveniently controlled via app, remote control, wall mount remote control, or even voice control, with Amazon Alexa and Google Assistant.

Climate control

The climate control devices offer demand-based room-by-room control of radiators throughout the entire house, enabling users to save up to 30 % on their energy costs. Homematic IP can also be used to efficiently control the underfloor heating. The system detects the required heat for individual rooms and – unlike conventional heating circuit control systems – intelligently circulates the hot water into the different heating zones. This provides load balancing and efficient energy distribution thanks to the continuous flow of heating water. Individual heating schedules can be created for every single room using the free app. Your heating is then automatically controlled, making everyday life easier. However, you can still react flexibly to changing circumstances and adjust the desired temperatures as you please.

Security & alarms

The Homematic IP devices for security and alarm applications increase protection against break-ins and make you feel safe in your own home. In alarm mode, you are informed whenever windows and doors are opened. Motion detectors and presence sensors reliably monitor inside and outside areas, while sirens sound the alarm in case of break-ins or fire. A quick glance at the app is all it takes to see that everything is as it should be at home – even if you're thousands of miles away. Even if the access point is destroyed or the internet connection is lost, you are still ensured reliable monitoring and local alarms. So you no longer need to worry about windows and doors being left open.

Light & shade

Convenient light switching and dimming creates a sense of well-being in your home. For instance, a comfortable atmosphere for your TV evening is created via the app as the ceiling light is dimmed to a desired brightness level while the floor lamp is switched on. And devices for controlling roller shutters and awnings create privacy and increase security by simulating presence. The actuators are conveniently controlled via individual week-long profiles that also factor in sunrise and sunset. And Homematic IP blind actuators allow the slat position of exterior and interior blinds to be precisely adjusted.



Access control

Have you ever forgotten your front door key and found yourself standing in front of a locked door? Or been sitting in your car, suddenly not sure whether you really locked that door or not? These problems are now a thing of the past: with Homematic IP, you can easily make your front door smart and turn your smartphone into a digital key.

You can lock and unlock your door at any time using the smartphone app, or just as easily using the practical remote control.

Weather & environment

With our weather sensors, the Homematic IP system is automatically adjusted to the current weather conditions. Paired with other Homematic IP devices, the sensors can automatically trigger commands for moving awnings, interior blinds or shutters up or down in response to certain weather conditions, actively protecting your home. And users have almost unlimited options for creating individual rules. For example, it is possible to automatically extend the awning to 80 % when the sun is shining strongly and the security mode is deactivated.

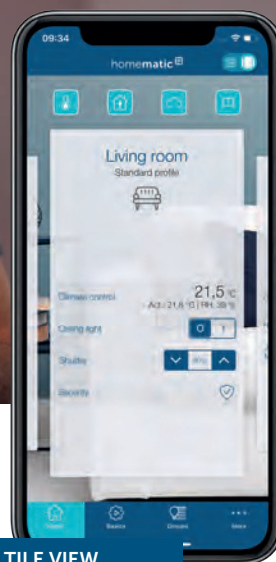
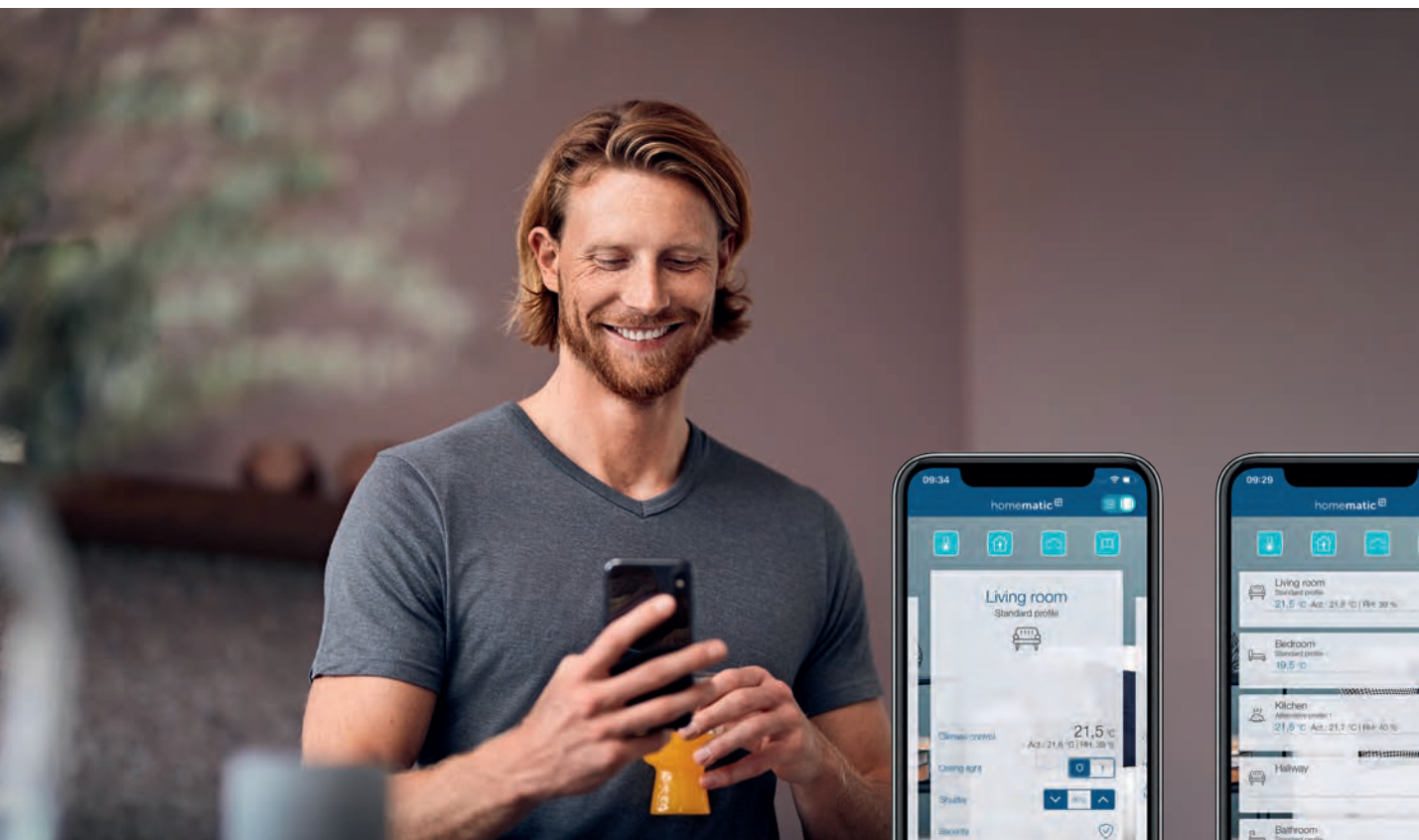

TILE VIEW



LIST VIEW



The Homematic IP App

Free, intuitive and clear! You think a smart home is too complicated? It doesn't have to be! With the Homematic IP app, you hold your whole home in the palm of your hand. From setup right through to daily operation. With the Homematic IP smartphone app, even complex applications can be completed in a few minutes. Once connected to the Homematic IP access point, the app becomes the smart hub for your installation. You operate your smart home and make all the configurations via the app, regardless of whether you are at home or away.

**YOUR
SMART HOME
IN ONE APP**

Homematic IP smartphone app

The free app for iOS and Android allows you to configure and control the Homematic IP smart home system via smartphone – without any recurring costs. The connection of new devices as well as the individual setup of the system are quick and easy thanks to the intuitive user guidance.



homematic IP
Smart Living, Simply Exciting.

THE ENTIRE SMART HOME IN ONE APP

Controls the entire smart home with a tap of your finger and provides an overview of the current status of all devices and functions in the system. In the event of an alarm, e.g. burglary, fire or water damages, users are immediately informed via push message and notification in the app.

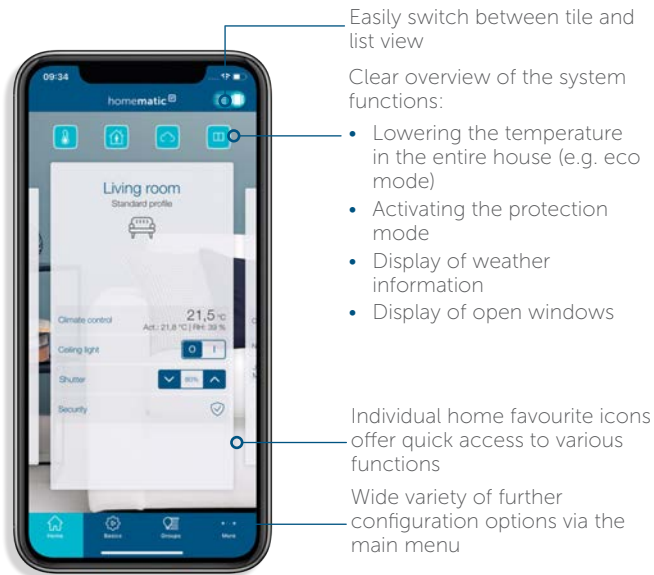

The main menu offers various additional configuration options for all applications in the Homematic IP smart home

Additional services like Amazon Alexa and Google Assistant are easily integrated

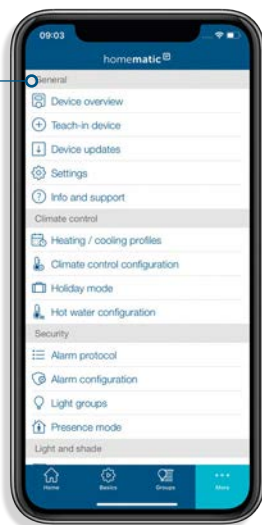

TECHNICAL SPECIFICATIONS

Operating systems	Android (from version 6) iOS (from version 10)
Costs	free (without recurring costs)
Languages	German English French Dutch Italian Spanish Polish Russian Norwegian Danish Swedish Finnish Czech

THE IDEAL APPLICATION FOR EACH FUNCTION

Intuitive app for easy operation right from the start: the Homematic IP app offers the ideal configuration option for all smart home applications. These include, for example, setting-up of individual heating profiles for each room, creating groups for controlling lights and shutters, activating the protection mode or eco mode – the energy-saving solution for climate control of all rooms. The automation function can even be used to easily program your own functions.

FREE UPDATES, MORE FUNCTIONS

The Homematic IP smartphone app is continuously updated and extended by additional functions – and that for free! So the app grows continuously with the demands of a smart home.

SMART CONTROL, NO MATTER WHEN AND WHERE

The entire smart home world can be operated and configured via the app, whether at home or while being on the road. Home favourites are available for quick access to individual functions, which can be defined by the user.

HIGHEST LEVEL OF SECURITY & DATA PROTECTION

- ✓ Awarded by VDE for highest information security
- ✓ Requires no personal data
- ✓ Operation of the Homematic IP cloud only via German servers



For operation, a Homematic IP Access Point has to be installed!

GET STARTED AND
EXPAND IN MANY
WAYS

Access Point

HMIP-HAP

The heart of your smart home: The Access Point offers comfortable set-up and control of the Homematic IP system using an intuitive smartphone app. The device connects all Homematic IP devices via the free cloud.



www.VDEinfo.com
ID. 40046786



homematic ^{IP}
Smart Living, Simply Exciting.



Simple installation:

1. Connect to the router
 2. Establish power-supply
 3. Scan the QR code
- Done ✓

The Access Point offers the right solution for every smart home:

- Extension of the wireless range by integrating an additional Access Point
- Controlling several Access Points in different installations (e.g. for a holiday home) via one app
- Up to 15 smartphones/users in each Homematic IP installation

TECHNICAL SPECIFICATIONS

Supply voltage	5 Vdc
Plug-in mains adapter (input)	100 V-240 V/50 Hz
Power consumption plug-in mains adapter	2.5 W max.
Current consumption	500 mA max.
Standby power consumption	1.1 W
Degree of protection	IP20
Ambient temperature	5 to 35 °C
Dimensions (W x H x D)	118 x 104 x 26 mm
Weight	153 g
Radio frequency band	868.0-868.6 MHz 869.4-869.65 MHz
Typ. open area RF range	400 m
Network	10/100 MBit/s, Auto-MDIX

EASY AND INTUITIVE SET-UP

The Access Point is supplied with power and connected to a standard router. That's it!

By connecting Homematic IP devices, a comprehensive smart home system can be individually established.

Set-up and control of devices is carried out using the free smartphone app with intuitive user guidance.

CONTROL YOUR SMART HOME FROM ANYWHERE

The app automatically enables access to the smart home system via the cloud at any time, even while you are on the move.

HIGH SECURITY ACCORDING TO GERMAN QUALITY STANDARDS

- ✓ The Access Point reliably detects radio interference in the installation and warns in case of interference
- ✓ AES 128 encryption between devices, app and cloud
- ✓ Server location in Germany
- ✓ Secure use without registration
- ✓ Reliable radio protocol based on 868/869.525 MHz

VOICE CONTROL FOR YOUR SMART HOME

A large number of the Homematic IP devices and system functions offers comfortable voice control using Amazon Alexa or Google Assistant.

EASY AND FLEXIBLE INSTALLATION

The Access Point is operated either lying on a table or permanently mounted on the wall. The screws and plugs for installation are delivered with the device.

LOGISTICAL DATA

Product reference	140887A0
EAN code	4047976408870
Short description	HMIP-HAP
Packing unit	32
Packing dimensions	184 x 140 x 73 mm
Weight incl. packaging	448.0 g

PACKAGE CONTENTS

Homematic IP Access Point
 Plug-in mains adapter
 Network cable
 Mounting material (screws and plugs)
 User manual

START NOW!

**FEEL SAFE & SECURE
IN YOUR SMART HOME**

Starter Set Alarm

HmIP-SK7

The easy start into smart monitoring of your home: Open windows or movements are quickly detected and immediately displayed as push notification on the smartphone. A loud alarm sound is immediately triggered via the alarm siren to chase burglars away.



www.VDEinfo.com
ID. 40046786

homematic ^{IP}
Smart Living, Simply Exciting.



Alarm message in the Homematic IP app

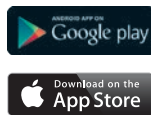

TECHNICAL SPECIFICATIONS

Access Point:

Supply voltage	Power supply unit (5 V)
Dimensions (W x H x D)	118 x 104 x 26 mm
Typical open area RF range	400 m

Motion detector – indoor:

Supply voltage	2x 1.5 V LR6/mignon/AA
Battery life	3 years (typ.)
Dimensions (W x H x D)	52 x 65 x 34 mm
Typical open area RF range	280 m
Detection range	12 m
Detection angle	105° horizontal/40° vertical

Window / Door Contact – optical:

Supply voltage	1x 1.5 V LR03/micro/AAA
Battery life	2 years (typ.)
Dimensions (W x H x D)	102 x 15 x 20 mm
Typical open area RF range	300 m

Alarm siren:

Supply voltage	3x 1.5 V LR6/mignon/AA
Battery life	2 years (typ.)
Dimensions (ø x H)	124 x 45 mm
Typical open area RF range	250 m
Volume Piezo loudspeaker:	≥ 90 dB @ a distance of 1 meter

For further technical details and information, please refer to the data sheet of the respective device.

CREATE A SECURE HOME WITH HOMEMATIC IP

Movements as well as opening and closing of windows and doors are detected reliably and immediately displayed in the Homematic IP app. The combination with the alarm siren finally completes the starter set: In case of danger, loud alarm sounds and two bright red LED lights make sure that you are immediately warned.

FAIL-SAFE AND RELIABLE

Alarms are triggered even without Internet or cloud connection due direct communication between the devices. Even if the Access Point is destroyed, by a burglar for example, the other devices remain active.

EVERYTHING IN SIGHT

The Homematic IP app provides a current overview of the smart home, providing for a secure feeling when you leave home or while being on the move.

COMFORTABLE VOICE CONTROL

In addition to operation via push-button, remote control or app, the alarm mode (absence or presence mode) can also be activated (not deactivated) via voice control with Amazon Alexa and Google Assistant.

HIGH SECURITY ACCORDING TO GERMAN QUALITY STANDARDS

- ✓ Secure use without registration
- ✓ AES 128 encryption between devices, app and cloud
- ✓ Server location in Germany
- ✓ Reliable radio protocol based on 868/869.525 MHz

EASY ENTRY INTO THE SMART HOME WORLD

Flexible extension to a comprehensive smart home is possible at any time thanks to the large Homematic IP product range.

LOGISTICAL DATA

Product reference	153348A0
EAN code	4047976533480
Short description	HmIP-SK7
Packing unit	6
Packing dimensions	325 x 194 x 150 mm
Weight incl. packaging	1626.5 g

PACKAGE CONTENTS

Homematic IP Access Point (plug-in power supply unit, network cable)
 Homematic IP Motion Detector with Brightness Sensor – indoor (with stand and wall mounting bracket)
 Homematic IP Window / Door Contact – optical (caps in white and brown)
 Homematic IP Alarm Siren
 Batteries and mounting material
 User manual

WELCOME TO SMART
HOME LIVING!

SMART AND PRACTICAL
ACCESS CONTROL

Starter Set Access

HmIP-SK14

You need never look for your key again with the smart access solution from Homematic IP! You can lock, unlock and open your front door easily and securely using your smartphone or remote control. And you can always keep an eye on your front door with the Homematic IP app.



www.VDEinfo.com
ID. 40046786

homematic ^{IP}
Smart living. Simply exciting.



ARE YOU SURE YOU LOCKED THE DOOR?

With scheduled locking, you'll never need to ask this question again. You can schedule the front door to lock automatically at any time you want (e.g. overnight). This not only increases the security of your smart home, but it also saves you from having to go and check the front door.

EASY TO RETROFIT

Simple installation on standard profile cylinders with emergency function – without damaging the door, frame or key. And battery operation means no wiring is required. For installation, the locking cylinder must protrude 8 to 15 mm on the inside of the door.



CONVENIENT & FLEXIBLE ACCESS CONTROL

You can now lock, unlock and even open your front door whenever you want – from wherever you want. Simply via the Homematic IP app or key ring remote control.

Another advantage: you can even securely lock the door via voice control with Amazon Alexa or Google Assistant.

YOU DECIDE WHO CAN ENTER

Thanks to configurable access authorizations, access to the smart home can be individually managed – regardless of the time of day or day of the week. The front door can only be opened when the occupier wants it to be. Thus, for example, cleaners or carers can access the house only with a remote control and at specific times.

NUMEROUS OTHER ADVANTAGES

- ✓ Can be opened and closed at any time with the control wheel (emergency function)
- ✓ The door can still be opened from the outside with an ordinary key
- ✓ Personal PINs to protect against unauthorised operation via the app

TECHNICAL SPECIFICATIONS

Access point:

Supply voltage	Power supply unit (5 VDC)
Dimensions (W x H x D)	118 x 104 x 26 mm
Typical range in open space	400 m

Door lock actuator:

Supply voltage	3x 1.5 V LR6/Mignon/AA
Battery life	1/2 year (typical)
Dimensions (W x H x D)	56 x 118 x 63 mm
Typical range in open space	200 m

Key Ring Remote Control:

Supply voltage	1x 1.5 V LR03/micro/AAA
Battery life	2 years (typical)
Ambient temperature	-10 to +55 °C
Dimensions (W x H x D)	38 x 75 x 14 mm
Typical range in open space	200 m

Further technical details and information can be found in the data sheet for the respective device.

GETTING STARTED IN A SMART HOME

The large selection of Homematic IP devices allows flexible expansion to a complete smart home at any time. This means numerous additional functions can be implemented, such as automatically switching on lights when you come home.

LOGISTICS DATA

Product reference	156033A0
EAN code	4047976560332
Short description	HmlP-SK14
Packing unit	6
Packing dimensions	325 x 159 x 106 mm
Weight incl. packaging	1154.6 g

PACKAGE CONTENTS

Homematic IP access point (plug-in power supply unit, network cable)
 Homematic IP door lock actuator (mounting plate)
 Homematic IP Key Ring Remote Control – Access
 Batteries
 Mounting accessories
 Operating manual

SMART
HEATING FOR
COMFORTABLE
LIVING

Starter set Heating

HmIP-SK16-2

The easy start to a smart home. Radiator Thermostats from Homematic IP enable individualised heating profiles to be created for pleasant indoor climates. The thermostats are easy to configure and control via the Homematic IP Access Point using an app – anytime, anywhere.



www.VDEinfo.com
ID: 40046786

homematic ^{IP}
Smart living. Simply exciting.

EASY TO INSTALL WITHOUT TOOLS

Access Point – Connects the devices to the app via the cloud



Automatic or manual operation of radiators



Create individualised heating profiles via the free Homematic IP app



GETTING STARTED WITH SMART HOMES

The large selection of Homematic IP devices enables flexible expansion to getting a complete smart home.

TECHNICAL SPECIFICATIONS

Access Point:

Supply voltage	Power supply unit (5 V)
Supply voltage plug-in mains adapter (input)	100 V-240 V/50 Hz
Power consumption in standby	1.1 W
Dimensions (W x H x D)	118 x 104 x 26 mm
Radio frequency band	868.0-868.6 MHz 869.4-869.65 MHz
Type Wireless open air range	400 m

Radiator Thermostat:

Supply voltage	2x 1.5 V LR6/Mignon/AA
Battery life	2 years (typ.)
Dimensions (W x H x D)	57 x 68 x 102 mm
Type Wireless open air range	250 m
Threaded connection	M30 x 1.5 mm

Further technical details and information can be found in the data sheet for the respective device.

COMFORT HEATING

Individualised temperature profiles can be created easily via an app – with up to 3 customisable heating profiles and 13 changes per day. This means that heating only takes place when warmth is needed.

SMART SAVINGS ON HEATING COSTS

Open-window detection ensures automatic lowering of temperatures when a window is open. This reduces heating costs while providing pleasant indoor climates.

Homematic IP Window and Door Contacts can also be integrated so that in combination with the heating profiles, savings up to 33% on valuable heating energy can be achieved.

FEEL-GOOD TEMPERATURES ANYTIME

The Homematic IP Access Point enables temperatures to be controlled from any location using the free Homematic IP app. Temperatures can then be adjusted at anytime during normal heating operation even when underway.

SMART CONTROL

Room temperatures can be controlled individually. There are three options for operation: in the device; via the app; by voice control (Amazon Alexa or Google Assistant).

MANY EXTRA FUNCTIONS

- ✓ Boost function: to quickly warm up a room
- ✓ Eco mode: energy-saving operation with reduced room temperatures
- ✓ Valve protection function: protection against calcification
- ✓ Operating lock: protection against unintentional operation

LOGISTICAL DATA

Product reference	156537A0
EAN code	4047976565375
Short description	HmIP-SK16-2
Packing unit	6
Packing dimensions	325 x 159 x 106 mm
Weight incl. packaging	1119.3 g

PACKAGE CONTENTS

Homematic IP Access Point (plug-in power supply unit, network cable)
 Homematic IP Radiator Thermostat – basic (2x)
 Danfoss adapter RA
 Batteries
 Mounting accessories
 Operating manual

TECHNOLOGY AND
DESIGN SMARTLY
COMBINED

Radiator Thermostat – Evo

HmIP-eTRV-E | HmIP-eTRV-E-S | HmIP-eTRV-E-A

Evo is the evolution in smart radiator thermostats, combining a simple and modern form with highly precise and virtually noiseless control. Individualised heating profiles and connectivity to window sensors can save up to 33% energy on heating.



Also available in silver and anthracite

homematic 
Smart living. Simply exciting.

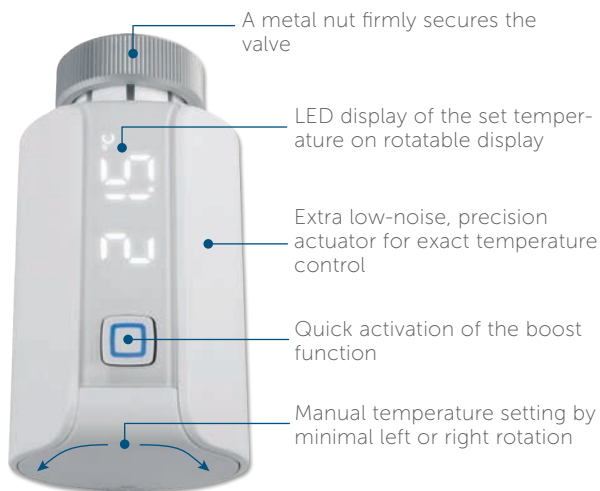

Individualised heating profiles via the free Homematic IP app



To enable operation, the device has to be connected with one of the following solutions:

- Homematic IP Access Point with free smartphone app and free cloud service
- Third-party partner solutions

TECHNICAL SPECIFICATIONS

Supply voltage	2x 1.5 V LR06/Mignon/AA
Battery life	2 years (typ.)
Degree of protection	IP20
Ambient temperature	0 to 50 °C
Dimensions (W x H x D)	53 x 55 x 94 mm
Weight	190 g (including batteries)
Radio frequency band	868.0-868.6 MHz 869.4-869.65 MHz
Typ. wireless open air range	230 m
Threaded connection	M30 x 1.5 mm

EASY SAVINGS ON HEATING COSTS

Individualised temperature profiles are easy to create using the app – with up to 3 customisable heating profiles and 13 changes per day. This means that heating only takes place when warmth is needed.

Any open windows and doors are detected via an open-window-detection function or even more precisely in combination with a Homematic IP Door / Window Contact. Heating temperatures are automatically lowered so that no energy is wasted.

FEEL-GOOD TEMPERATURES ANYTIME

Room temperature is controlled according to user need: easily via the app – at home or while on the go – using the device or by voice control (via Amazon Alexa or Google Assistant).

MODERN DESIGN AND OPTIMAL OPERATION

A white backlit LED display means set temperatures are very easy to read. The display is on during operation and can be rotated to the left or right depending on installation. The minimalist and elegant housing design makes the high-quality radiator thermostat perfect for any interior look.

QUICK AND EASY TO INSTALL

High-quality metal union nut for secure mounting on all common M30 threaded radiator valves. Installation is quick and easy with no need to interfere with heating system or drain water.

OTHER FEATURES

- ✓ Very quiet operation for use in bedrooms
- ✓ Boost function for quick room heating
- ✓ Eco mode for energy-saving operation with reduced room temperatures
- ✓ Valve protection function against calcification
- ✓ Operating lock prevents unintentional operation

LOGISTICAL DATA

Version	White	Silver	Anthracite
Product reference	155105A0	156650A0	158419A0
EAN code	4047976551057	4047976566501	4047976584192
Short description	HmIP-eTRV-E	HmIP-eTRV-E-S	HmIP-eTRV-E-A
Packing unit	45		
Packing dimensions	122 x 112 x 97 mm		
Weight incl. pack-aging	359,9 g		

PACKAGE CONTENTS

Homematic IP Radiator Thermostat – Evo
 Adapters Danfoss (RA, RAV and RAVL)
 Support ring and installation material
 1.5 V LR6/mignon/AA batteries (2x)
 Operating manual

SMART HEATING
CONTROL WITH
UP TO 33 %
IN ENERGY SAVINGS

Radiator Thermostat

HmIP-eTRV-2

The smart Homematic IP Radiator Thermostat saves up to 33% on energy thanks to individual heating profiles and connected window contacts. This reduces heating costs, lowers CO₂ emissions and provides comfortable temperatures for your smart home.



homematic ^{IP}
Smart Living, Simply Exciting.



Individual heating profiles via the free Homematic IP app



To enable operation, the device has to be connected with one of the following solutions:

- Homematic IP Access Point with free smartphone app and free cloud service
- Third-party solutions of partners

TECHNICAL SPECIFICATIONS

Supply voltage	2x 1.5 V LR6/mignon/AA
Battery life	2 years (typ.)
Degree of protection	IP20
Ambient temperature	0 to 50 °C
Dimensions (W x H x D)	58 x 71 x 97 mm
Weight	205 g (incl. batteries)
Radio frequency band	868.0-868.6 MHz 869.4-869.65 MHz
Typical open area RF range	300 m
Threaded connection	M30 x 1.5 mm

SAVE HEATING COSTS

Individual temperature profiles are easily created via app – with up to 3 adjustable heating profiles and 13 changes per day. In this way, heating is carried out only if necessary. And during ventilation, the room temperature is automatically lowered thanks to the open-window function.

COMFORT TEMPERATURE AT ALL TIMES

The room temperature is controlled according to the individual needs of the user: simply via app, whether at home or on the road, directly on the device using the control wheel or conveniently via voice control (via Amazon Alexa or Google Assistant).

OPEN-WINDOW DETECTION

The Homematic IP Window and Door Contact offers exact detection of open windows and doors. The room temperature is automatically reduced to avoid any waste of energy.

SECURE AND EASY INSTALLATION

High-quality metal nut for secure installation to standard radiator valves with M30 thread size. Quick and easy installation without having to drain any water or intervening in the heating system.

MANY ADDITIONAL FUNCTIONS

- ✓ Whisper mode for quiet operation even in bedrooms
- ✓ Boost function for quick heating of rooms
- ✓ Eco mode for energy-saving operation with reduced room temperature
- ✓ Valve protection function against calcification of the valve
- ✓ Operating lock against unauthorised operation

LOGISTICAL DATA

Product reference	140280A0
EAN code	4047976402809
Short description	HmIP-eTRV-2
Packing unit	45
Packing dimensions	122 x 112 x 97 mm
Weight incl. packaging	338.6 g

PACKAGE CONTENTS

Homematic IP Radiator Thermostat
Adapters Danfoss (RA, RAV and RAVL)
Support ring and mounting material
1.5 V LR6/mignon/AA batteries (2x)
User manual

THE FIRST STEP
INTO SMART
HEATING

Radiator Thermostat – basic

HmlIP-eTRV-B-2

With or without control unit: The smart Homematic IP Radiator Thermostat saves up to 33% on energy. This reduces heating costs, lowers CO₂ emissions and provides comfortable temperatures.



homematic **IP**
Smart Living, Simply Exciting.

SAVE HEATING COSTS

Individual temperature profiles are easily created via app – with up to 3 adjustable heating profiles and 13 changes per day. In this way, the heating is switched on only if needed. And during ventilation, the room temperature is automatically reduced thanks to the open-window function.

COMFORT TEMPERATURE AT ALL TIMES

The room temperature is controlled according to the individual needs of the user: simply via app, whether at home or on the road, directly on the device using the push-buttons or conveniently via voice control (via Amazon Alexa or Google Assistant).

OPEN-WINDOW DETECTION

The Homematic IP Window and Door Contact offers exact detection of open windows and doors. The room temperature is automatically reduced to avoid any waste of energy.



Individual heating profiles via the free Homematic IP app



TECHNICAL SPECIFICATIONS

Supply voltage	2x 1.5 V LR6/mignon/AA
Current consumption	100 mA max.
Battery life	2 years (typ.)
Degree of protection	IP20
Ambient temperature	0 to 50 °C
Dimensions (W x H x D)	57 x 68 x 102 mm
Weight	185 g (including batteries)
Radio frequency band	868.0-868.6 MHz 869.4-869.65 MHz
Typical open area RF range	250 m
Connection	M30 x 1.5 mm

SECURE AND EASY INSTALLATION

The union nut enables secure installation to standard radiator valves with M30 thread size. Quick and easy installation without having to drain any water or intervening in the heating system.

MANY ADDITIONAL FUNCTIONS

- ✓ Boost function for quick heating of rooms
- ✓ Eco mode for energy-saving operation with reduced room temperature
- ✓ Valve protection function against calcification of the valve
- ✓ Operating lock against unauthorised operation

FLEXIBLE CONTROL OPTIONS

Stand-alone operation (push-to-pair):

- ✓ Manual operation and configuration directly on the device, e.g. for setting the heating profile, holiday mode, temperature changes, etc.
- ✓ Direct pairing of up to eight window/door contacts (HmIP-SWDM) and one wall thermostat (HmIP-WTH-B) possible

In a smart home together with the Homematic IP Access Point:

- ✓ Configuration and control via the free Homematic IP smartphone app
- ✓ Can be extended to a comprehensive smart home solution at any time

To enable operation, the device has to be connected with one of the following solutions:

- Stand-alone (push-to-pair)
- Homematic IP Access Point with free smartphone app and free cloud service
- Third-party solutions of partners



LOGISTICAL DATA

Product reference	153412A2	153412A0
EAN code	4047976534128	4047976534128
Short description	HmIP-eTRV-B-2	HmIP-eTRV-B-2
Packing unit	45	36
Packing dimensions	120 x 70 x 97 mm	122 x 140 x 97 mm
Weight incl. packaging	271,1 g	340,0 g

PACKAGE CONTENTS

Homematic IP Radiator Thermostat – basic
 Danfoss RA adapter
 Support ring
 Mounting accessories
 1.5 V LR6/mignon/AA batteries (2x)
 User manual

Comparison of Homematic IP Radiator Thermostats

Comparison criteria	Radiator Thermostat – Evo <i>The evolution of smart heating</i>	Radiator Ttermostat <i>The Bestseller</i>	Radiator Thermostat – basic <i>The starter model</i>
Short description	HmIP-eTRV-E	HmIP-eTRV-2	HmIP-eTRV-B-2
Product image			
Heating cost savings of up to 33 %	✓	✓	✓
Thread size M30 x 1,5 mm	✓	✓	✓
Connection Nut	Metal nut	Metal nut	Plastic nut
Supply voltage	Batteries (2x 1,5 V LR6/Mignon/AA)	Batteries (2x 1,5 V LR6/Mignon/AA)	Batteries (2x 1,5 V LR6/Mignon/AA)
Battery life in years (typ.)	2	2	2
Dimensions (W x H x D)	53 x 55 x 94 mm	58 x 71 x 97 mm	57 x 68 x 102 mm
Weight (incl. batteries)	190 g	205 g	185 g
Typ. radio free-field range	230 m	300 m	250 m
Radio frequency band	868,0-868,6 MHz 869,4-869,65 MHz	868,0-868,6 MHz 869,4-869,65 MHz	868,0-868,6 MHz 869,4-869,65 MHz
Display	✓ Illuminated LED-Display	✓ Illuminated LC-Display	✓ LC-Display
Display direction adjustable	✓	No	No
Number of heating profiles	3	3	1 (when programmed on the device) 3 (when programmed via App)
Boost function	✓	✓	✓
Holiday mode	✓	✓	✓
Whisper mode	Not required, as already low-noise in operation	✓	No
Eco mode	✓	✓	✓
Open-window detection	✓	✓	✓
Automatic frost protection	✓	✓	✓
Valve protection function (descaling)	✓	✓	✓
Programmable operation lock	✓	✓	✓
Mechanical operation lock	No	No	No
Battery compartment lockable	No	No	No
Dismounting protection	Available as accessory	Available as accessory	No
Cloud operation with access point supported	✓	✓	✓
Local operation with CCU3 supported	✓	✓	✓
Operation on the device supported	✓	✓	✓
Programming on the device supported	No	No	✓
Max. number of radiator thermostats (per room)	8	8	8
Max. number of connectable window contacts (per room)	8	8	8
Compatible with Amazon Alexa	✓	✓	✓
Compatible with Google Assistant	✓	✓	✓

THE IDEAL
TEMPERATURE
FOR YOUR HOME

Wall Thermostat with Humidity Sensor

HmIP-WTH-1 | HmIP-WTH-A

The wall thermostat provides for intelligent control of the temperature in a room – via the control wheel or smartphone app. Several radiator thermostats or floor heating circuits can be controlled in one room. The current temperature and humidity are displayed via the illuminated LC display.



Available in white and anthracite

homematic ^{IP}
Smart Living, Simply Exciting.

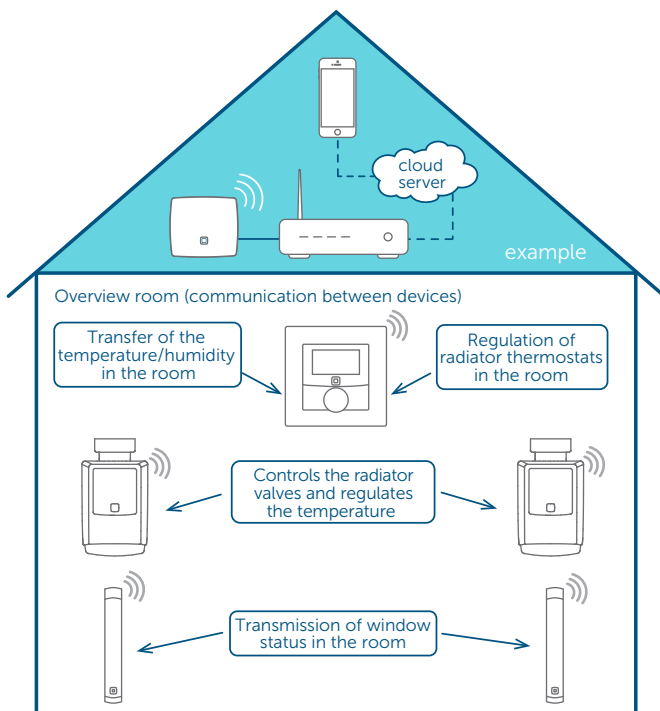

INTELLIGENT CONTROL

Individual temperature profiles are easily created via app – with up to 3 adjustable heating profiles and 13 changes per day. The temperature is regulated automatically and the heating is only switched on if necessary.

The temperature can be precisely adjusted in steps of 0.5°C using the control wheel. With the boost function, rooms be heated up quickly at the push of a button.

Operation requires connection to one of the following solutions:

- Stand-alone in connection with a wireless floor heating actuator (without Access Point, configuration directly via wall thermostat)
- Homematic IP Access Point with free smartphone app and free cloud service
- Third-party solutions of partners

TECHNICAL SPECIFICATIONS

Supply voltage	2x 1.5 V LR03/micro/AAA
Battery life	2 years (typ.)
Degree of protection	IP20
Ambient temperature	0 to 35 °C
Dimensions (W x H x D)	
Without frame:	55 x 55 x 23.5 mm
Including frame:	86 x 86 x 25 mm
Weight	100 g (including batteries)
Radio frequency band	868.0-868.6 MHz 869.4-869.65 MHz
Typ. open area RF range	250 m

COMFORT TEMPERATURE AT ALL TIMES

The room temperature is controlled according to the individual needs of the user: directly on the device using the control wheel, via app, whether at home or on the road, or even via voice control (with Amazon Alexa or Google Assistant).

ALWAYS HAVE THE TEMPERATURE IN SIGHT

Measures the temperature and humidity and constantly transmits the data to the radiator thermostats in the room as well as to the Homematic IP app. In this way, the current temperature and humidity per room are continuously displayed in the app.

EASY TO RETROFIT

Easy installation without any wiring effort thanks to battery operation and radio communication. This allows the thermostat to be placed anywhere in the room in order to measure the room temperature at the right place.

Conventional electric radiators can also be easily retrofitted in conjunction with the wall thermostat and a switch actuator for smart and precise control.

MODULAR DESIGN FOR HIGH FLEXIBILITY

As the design can be flexibly combined, the wall thermostat can be fixed at almost every mounting location:

- ✓ Adhesive or screw mounting in the supplied clip-on frame with enclosed mounting material
- ✓ Integration into existing switches with 55 mm frames of the the most common manufacturers
- ✓ Installation on a free flush-mounted box with corresponding mounting plate
- ✓ Integration into Homematic IP Desk Stand (HmIP-DS55) for increased battery lifetime
- ✓ As an alternative to battery operation, the wall thermostat can also be supplied with 230 V via the Homematic IP Power Supply Unit for brand switches (HmIP-BPS-2)

LOGISTICAL DATA

Version	White	Anthracite
Product reference	156669A0	159820A0
EAN code	4047976566693	4047976598205
Short description	HmIP-WTH-1	HmIP-WTH-A
Packing unit	90	90
Packing dimensions	122 x 112 x 48 mm	122 x 112 x 48 mm
Weight incl. packaging	208,5 g	208,5 g

PACKAGE CONTENTS

Homematic IP Wall Thermostat with Humidity Sensor
 Clip-on frame and mounting plate
 Mounting material (screws, plugs and adhesive strips)
 1.5 V LR03/micro/AAA batteries (2x)
 User manual

THE IDEAL
TEMPERATURE
FOR YOUR HOME

Wall Thermostat – basic

HmlIP-WTH-B-2

With or without control unit: The wall thermostat provides for intelligent control of the temperature in a room – via smartphone app or directly on the device. Several radiator thermostats or floor heating circuits can be controlled in one room. The current temperature and humidity are always shown on the clear LC display.



homematic ^{IP}
Smart Living, Simply Exciting.

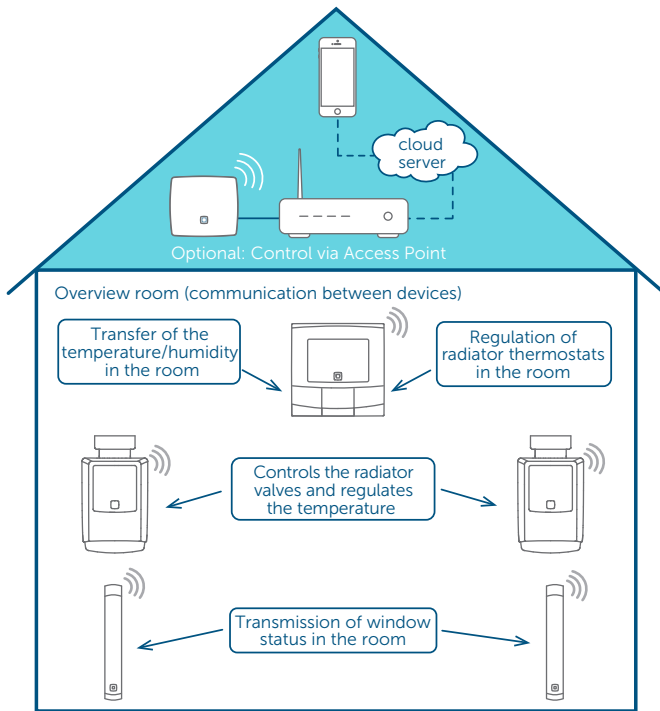

INTELLIGENT CONTROL

Individual temperature profiles can easily be created via the app – with up to 3 configurable heating profiles and 13 changes per day. The temperature is regulated automatically and heating is only carried out if necessary.

The temperature can be precisely adjusted in steps of 0.5°C using the push-buttons. With the boost function, the room can be heated quickly at the push of a button.

Operation requires connection to one of the following solutions:

- Stand-alone (push-to-pair)
- Homematic IP Access Point with free smartphone app and free cloud service
- Third-party solutions of partners

TECHNICAL SPECIFICATIONS

Supply voltage	2x 1.5 V LR6/mignon/AA
Battery life	5 years (typ.)
Degree of protection	IP20
Ambient temperature	0 to 50 °C
Dimensions (W x H x D)	85 x 85 x 25 mm
Weight	140 g (including batteries)
Radio frequency band	868.0-868.6 MHz 869.4-869.65 MHz
Typ. open area RF range	250 m

COMFORT TEMPERATURE AT ALL TIMES

The room temperature is controlled in accordance with the user's individual requirements: directly on the device, easily via the app, whether at home or on the move, or conveniently via voice control (using Amazon Alexa or Google Assistant).

ALWAYS HAVE THE TEMPERATURE IN SIGHT

Measures the temperature and humidity and constantly transmits the data to the radiator thermostats in the room as well as to the Homematic IP app. That way, the actual temperature and humidity in each room are visible via the app or the large LC display at any time.

EASY TO RETROFIT

Easy installation without any wiring effort thanks to battery operation and radio communication. This means the thermostat can be placed anywhere in the room to measure the room temperature in the right place.

Conventional electric radiators can also be easily retrofitted in conjunction with the wall thermostat and a switch actuator for smart and precise control.

FLEXIBLE CONTROL OPTIONS

Stand-alone operation (push-to-pair):

- ✓ Manual operation and configuration directly on the device, e.g. for setting the heating profile, holiday mode, temperature changes, etc.
- ✓ Direct pairing of up to eight radiator thermostats (HmIP-eTRV-B, HmIP-eTRV-b-2), window/door contacts (HmIP-SWDM, HmIP-SWDM-2) or floor heating actuators (HmIP-FAL- x) possible

In a smart home together with the Homematic IP Access Point:

- ✓ Configuration and control via the free Homematic IP smartphone app
- ✓ Can be extended to a comprehensive smart home solution at any time

LOGISTICAL DATA

Product reference	154666A0
EAN code	4047976546664
Short description	HmIP-WTH-B-2
Packing unit	60
Packing dimensions	122 x 112 x 73 mm
Weight incl. packaging	274.7 g

PACKAGE CONTENTS

Homematic IP Wall Thermostat – basic
 Wall mounting bracket
 Double-sided adhesive strips (2x)
 Screws (2x) and plugs (2x)
 1.5 V LR6/mignon/AA batteries (2x)
 User manual

THE RIGHT
TEMPERATURE AT
ALL TIMES

Temperature and humidity sensor with display – indoor

HmIP-STHD

The temperature and humidity sensor manages the intelligent, timer-based control of the room temperature in your smart home. With the Homematic IP App, several radiator thermostats or underfloor heating circuits can be controlled in each room. To give you a permanently up-to-date overview, the temperature and humidity are always shown on the illuminated LC display.



homematic ^{IP}
Smart living. Simply exciting.

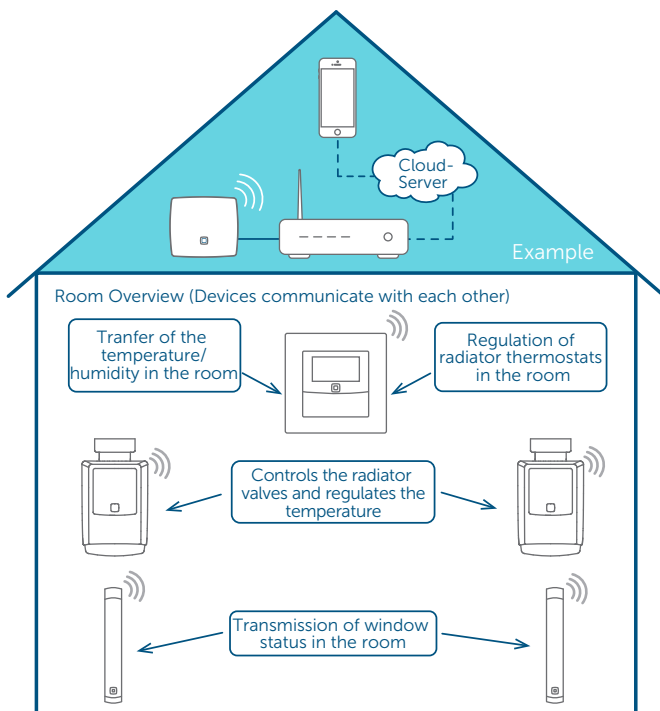

THE PERFECT TEMPERATURE AT ALL TIMES

Room temperatures are easily controlled according to user need – whether you are at home or not – via either an app or voice control (using Amazon Alexa or Google Assistant).

KEEPING AN EYE ON AIR TEMPERATURE

The intelligent thermostat measures the temperature and humidity and constantly forwards this information to the radiator thermostats in the room and to the Homematic IP app. This means that the current temperature and humidity can be viewed not only on the display, but also at any time via the app.

EASY TO RETROFIT

Simple installation without wiring thanks to battery operation and radio communication. So the thermostat can be placed wherever you need in the room to measure the room temperature in the right place.

Conventional, electric heaters can also be easily retrofitted using the thermostat and a switching actuator for smart two-point control.

INTELLIGENT CONTROL

Customised temperature schedules are easy to create using an app – with up to 3 adjustable heating schedules and 13 changes a day. As a result, your temperature control is fully automatic, and rooms are only heated when needed.

To enable operation, the device must be connected with one of the following solutions:

- Homematic IP Access Point with free smartphone app and free cloud service
- Third-party partner solutions

MODULAR DESIGN ENSURES HIGH FLEXIBILITY

Thanks to its flexibly combinable design, the thermostat can be fixed in almost any mounting position:

- ✓ adhesive or screw mounting in the interchangeable frame supplied using the enclosed mounting material
- ✓ Integration into existing switch systems (with 55 mm frames) from the most popular manufacturers
- ✓ Mounting on a free flush-mounted box with the mounting plate optimised for this purpose

TECHNICAL SPECIFICATIONS

Supply voltage	2x 1.5 V LR03/micro/AAA
Battery life	2 years (typical)
Degree of protection	IP20
Ambient temperature	5 to 35 °C
Dimensions (W x H x D)	
Without frame:	55 x 55 x 23.5 mm
Including frame:	86 x 86 x 25 mm
Weight	65 g (including batteries)
Radio frequency band	868.0–868.6 MHz 869.4–869.65 MHz
Typical radio free-field range	180 m
Humidity accuracy (typically)	± 3 % (in a range of 20 and 80 %)
Temperature accuracy (typically)	± 0.3 °C (in a range of 5 to 60 °C)

LOGISTICS DATA

Product reference	150180A0
EAN code	4047976501809
Short description	HmlIP-STHD
Packing unit	90
Packing dimensions	122 x 112 x 48 mm
Weight incl. packaging	177.6 g

PACKAGE CONTENTS

Homematic IP temperature and humidity sensor with display – indoor

Clip-on frame and mounting plate

Mounting material (screws, plugs and adhesive strips)

1.5 V LR03/micro/AAA batteries (2x)

Operating manual

THE RIGHT
TEMPERATURE AT ALL
TIMES

Temperature and humidity sensor – indoor

HmlIP-STH

The temperature and humidity sensor manages the intelligent, timer-based control of the room temperature in your smart home. With the Homematic IP App, several radiator thermostats or underfloor heating circuits can be controlled in each room.



homematic ^{IP}
Smart living. Simply exciting.

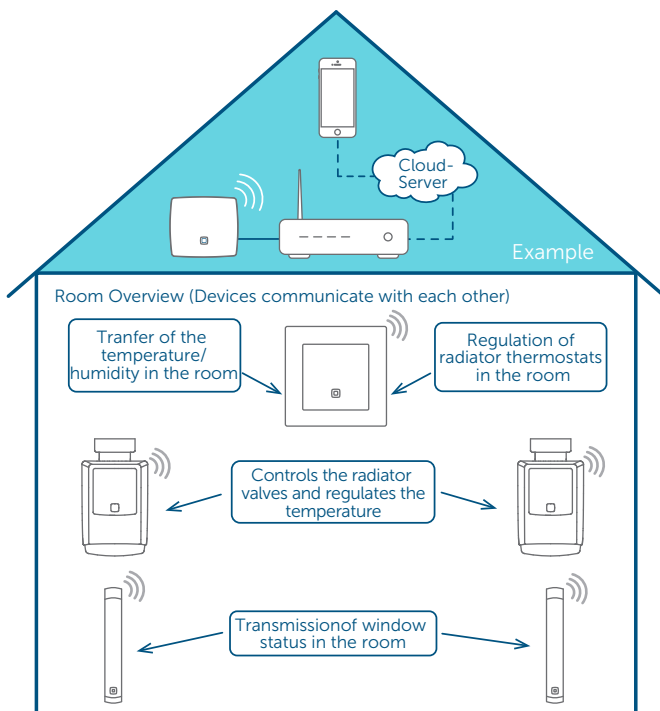

THE PERFECT TEMPERATURE AT ALL TIMES

Room temperatures are easily controlled according to user need – whether you are at home or not – via either an app or voice control (using Amazon Alexa or Google Assistant).

KEEPING AN EYE ON AIR TEMPERATURE

The intelligent thermostat measures the temperature and humidity and constantly forwards this information to the radiator thermostats in the room and to the Homematic IP app. This means that the current temperature and humidity in each room can be viewed at any time via the app.

EASY TO RETROFIT

Simple installation without wiring thanks to battery operation and radio communication. So the thermostat can be placed wherever you need in the room to measure the room temperature in the right place.

Conventional, electric heaters can also be easily retrofitted using the thermostat and a switching actuator for smart two-point control.

INTELLIGENT CONTROL

Customised temperature schedules are easy to create using an app – with up to 3 adjustable heating schedules and 13 changes a day. As a result, your temperature control is fully automatic, and rooms are only heated when needed.

To enable operation, the device must be connected with one of the following solutions:

- Homematic IP Access Point with free smartphone app and free cloud service
- Third-party partner solutions

MODULAR DESIGN ENSURES HIGH FLEXIBILITY

Thanks to its flexibly combinable design, the thermostat can be fixed in almost any mounting position:

- ✓ adhesive or screw mounting in the interchangeable frame supplied using the enclosed mounting material
- ✓ Integration into existing switch systems (with 55 mm frames) from the most popular manufacturers
- ✓ Mounting on a free flush-mounted box with the mounting plate optimised for this purpose

TECHNICAL SPECIFICATIONS

Supply voltage	2x 1.5 V LR03/micro/AAA
Battery life	2 years (typical)
Degree of protection	IP20
Ambient temperature	5 to 35 °C
Dimensions (W x H x D)	
Without frame:	55 x 55 x 19 mm
Including frame:	86 x 86 x 20 mm
Weight	85 g (including batteries)
Radio frequency band	868.0–868.6 MHz 869.4–869.65 MHz
Typical radio free-field range	130 m
Humidity accuracy (typically)	± 3 % (in a range of 20 and 80 %)
Temperature accuracy (typically)	± 0.3 °C (in a range of 5 to 60 °C)

LOGISTICS DATA

Product reference	150181A0
EAN code	4047976501816
Short description	HmIP-STH
Packing unit	90
Packing dimensions	122 x 112 x 48 mm
Weight incl. packaging	163.0 g

PACKAGE CONTENTS

Homematic IP temperature and humidity sensor – indoor
 Clip-on frame and mounting plate
 Mounting material (screws, plugs and adhesive strips)
 1.5 V LR03/micro/AAA batteries (2x)
 Operating manual

Comparison of Homematic IP Wall Thermostats

Comparison criteria	Wall thermostat with Humidity sensor <i>The classic</i>	Wall thermostat – basic <i>The starter model</i>	Temperature and humidity sensor with display – indoor <i>Everything at a glance</i>	Temperature and humidity sensor – indoor <i>The discreet one</i>
Short description	HmIP-WTH-1	HmIP-WTH-B-2	HmIP-STHD	HmIP-STH
Product image				
Supply voltage	Batteries (2x 1,5 V LR03/Micro/AAA)	Batteries (2x 1,5 V LR03/Micro/AAA)	Batteries (2x 1,5 V LR03/Micro/AAA)	Batteries (2x 1,5 V LR03/Micro/AAA)
Battery life in years (typ.)	2	5	2	2
Dimensions (W x H x D) without frame with frame	55 x 55 x 23,5 mm 86 x 86 x 25 mm	85 x 85 x 22 mm	55 x 55 x 23,5 mm 86 x 86 x 25 mm	55 x 55 x 19 mm 86 x 86 x 20 mm
Weight (incl. batteries)	100 g	185 g	65 g	85 g
Typ. radio free-field range	250 m	250 m	180 m	130 m
Radio frequency band	868,0-868,6 MHz/869,4-869,65 MHz	868,0-868,6 MHz/869,4-869,65 MHz	868,0-868,6 MHz/869,4-869,65 MHz	868,0-868,6 MHz/869,4-869,65 MHz
Display	✓ Illuminated LC-Display	✓ LC-Display	✓ LC-Display	No Display
Number of heating profiles	3	1 (when programmed on the device) 3 (when programmed via App)	3	3
Boost function	✓	✓	No (only via App)	No (only via App)
Holiday mode	✓	✓	No (only via App)	No (only via App)
Programmable operation lock	✓	✓	-	-
Cloud operation with access point supported	✓	✓	✓	✓
Local operation with CCU3 supported	✓	✓	✓	✓
Stand-alone-operation supported	No	✓ Direct teach-in to HmIP-SWDM-2, HmIP-eTRV-B-2, and HmIP-FAL (different variants) possible	No	No
Max. number of radiator thermostats (per room)	8	8	8	8
Max. number of connectable window contacts (per room)	8	8	8	8
Operation on the device supported	✓ By rotary wheel	✓ By buttons	No (only via App)	No (only via App)
Programming on the device supported	✓	✓	No (only via App)	No (only via App)
Compatible with Amazon Alexa (with HmIP-HAP)	✓	✓	✓	✓
Compatible with Google Assistant (with HmIP-HAP)	✓	✓	✓	✓
Integration in switch series (55mm frame dimension) possible	✓	No	✓	✓

INFINITELY VARIABLE
TEMPERATURE
ADJUSTMENT FOR THE
PERFECT INDOOR CLIMATE

Floor Heating Controller – 12 channels, motorised

HmIP-FALMOT-C12

No more cold feet: With the Homematic IP Floor Heating Controller, used together with the motorised valve drives from Homematic IP, floor heating systems can be easily controlled and even retrofitted. The controller's infinitely variable and energy-efficient control of up to 12 individual heating circuits ensures the temperature is always right in every room.



homematic ^{IP}
Smart living. Simply exciting.

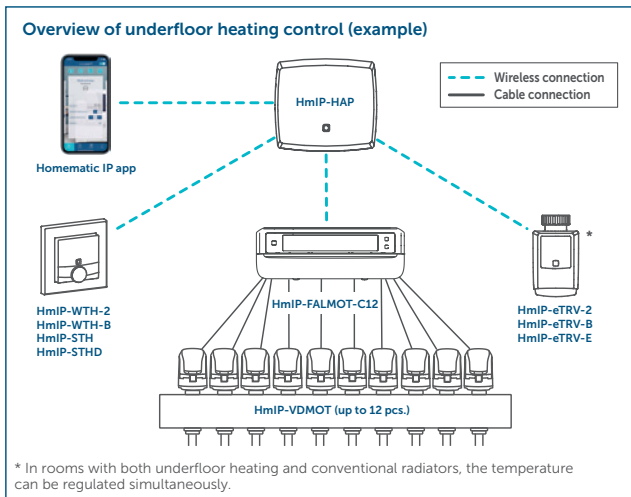

THE IDEAL TEMPERATURE IN EVERY ROOM

Used together with the motorised valve drives from Homematic IP, the smart floor heating controller ensures efficient floor heating for up to 12 heating zones. Individual temperature schedules can be set with up to 13 changes a day in 6 heating schedules (3x heating/3x cooling). Flexible regulation is carried out via a free smartphone app or directly on the Homematic IP Wall Thermostat.

PRECISE TEMPERATURE CONTROL

The controller enables a constant flow of heating water, also adapted to different floor structures. Modern control algorithms enable an even and efficient utilisation of the heating system even with low heat demand. Instead of conventional thermal actuators (open/close), the control is carried out via motorised actuators (HmIP-VDMOT) - these enable dynamic adaptive balancing of the individual rooms.

TECHNICAL SPECIFICATIONS

Supply voltage	230 V/50 Hz or 24 VDC/SELV
Current consumption	500 mA max. or 375 mA max. (at 24 VDC/SELV)
Cable type and cross section	rigid and flexible cable, 0.12-0.5 mm ²
Degree of protection	IP20
Ambient temperature	0 to 50° C
Dimensions (W x H x D)	242 x 85 x 52 mm
Weight	440 g
Radio frequency band	868.0-868.6 MHz 869.4-869.65 MHz
Typical radio free-field range	320 m
Max. number of heating zones	12
Connection cable length	1.5 m

SMART AND SIMPLE RETROFITTING

Existing floor heating systems can be easily retrofitted. The use of secure wireless communication means that no new cables need to be laid. And, because all the necessary devices can be commissioned directly on site, even without an internet connection, the products are also ideal for new buildings.

EASY INSTALLATION

The screwless plug-in/clamp connection technology enables easy, tool-free installation. The valve drives are simply connected to the floor heating controller with snap-on connectors.

The illuminated display clearly shows the status of the valves, making commissioning and function tests easier.

FLEXIBLE USE

The controller regulates floor heating systems and other water-based surface heating systems, such as wall heating systems. In addition, it is possible to connect it to the Multi IO Box or the switching actuator for heating systems, for example, to control a circulation pump or boiler, and for switching between heating and cooling mode. This means that rooms can even be pleasantly cooled in summer.

Several floor heating controllers can be used simultaneously in one house.

A wall thermostat can be used to control several heating systems in a room.

Operation requires connection to one of the following solutions:

- Stand-alone (no Access Point or Central Control Unit, configuration directly on the Homematic Wall Thermostat (HmIP-WTH-2, HmIP-WTH-B, HmIP-BWTH or HmIP-BWTH24))
- Homematic IP Access Point with free smartphone app and free cloud service
- Third-party partner solutions

LOGISTICS DATA

Product reference	153621A0
EAN code	4047976536214
Short description	HmIP-FALMOT-C12
Packing unit	12
Packing dimensions	184 x 281 x 97 mm
Weight incl. packaging	917.0 g

PACKAGE CONTENTS

Homematic IP Floor Heating Controller – 12 channels, motorised
Power cable
Mounting material (2x screws, 2x plugs)
Operating manual

**SIMPLE AND
CONVENIENT
CLIMATE CONTROL**

Valve drive – motorised

HmIP-VDMOT

Used together with Homematic IP's motorised floor heating controllers, the motorised valve drives from Homematic IP ensure infinitely variable, energy-efficient climate control via the floor heating valves. This means rooms are at the optimum temperature at any time day or night, and you save on energy costs too.

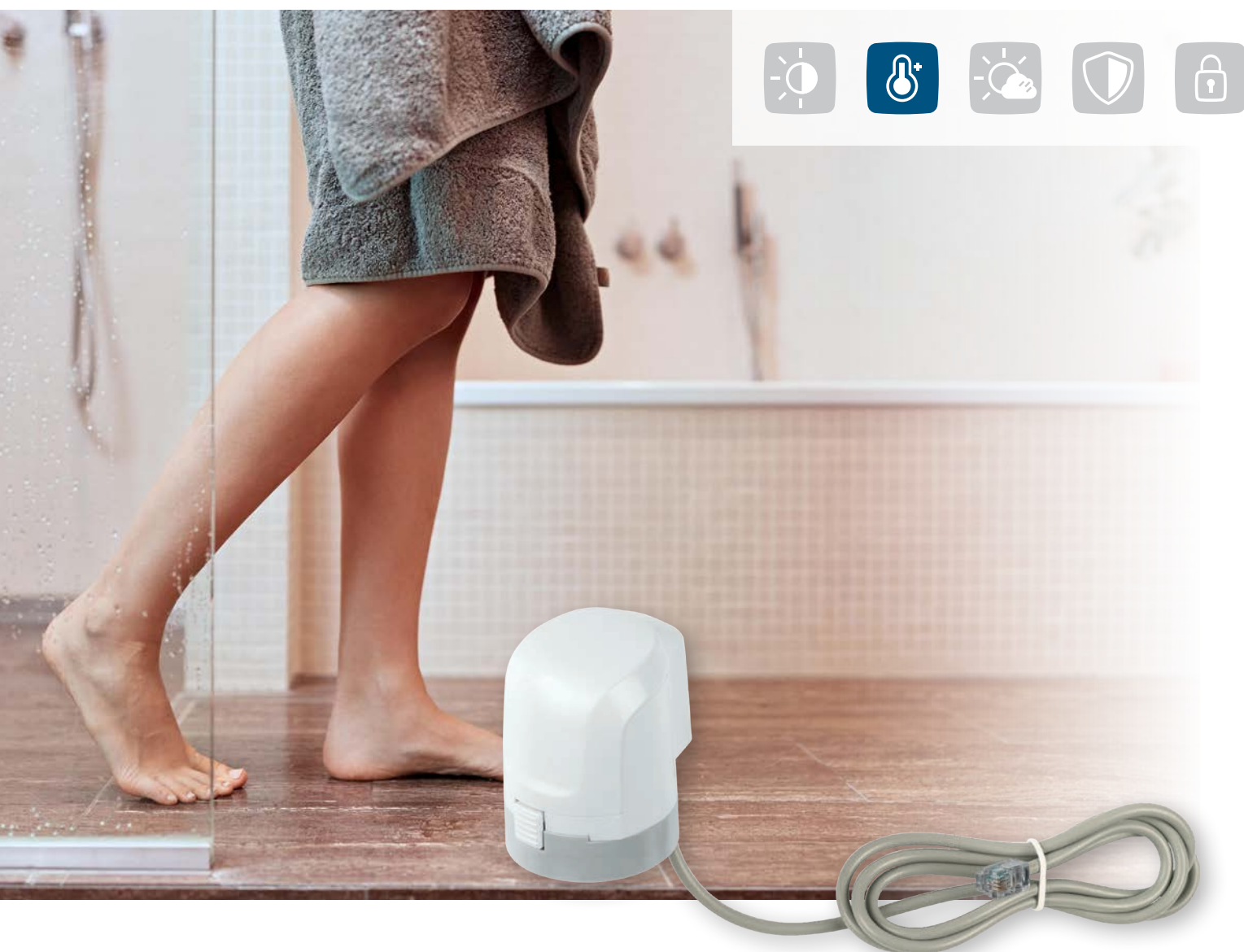

homematic 
Smart living. Simply exciting.

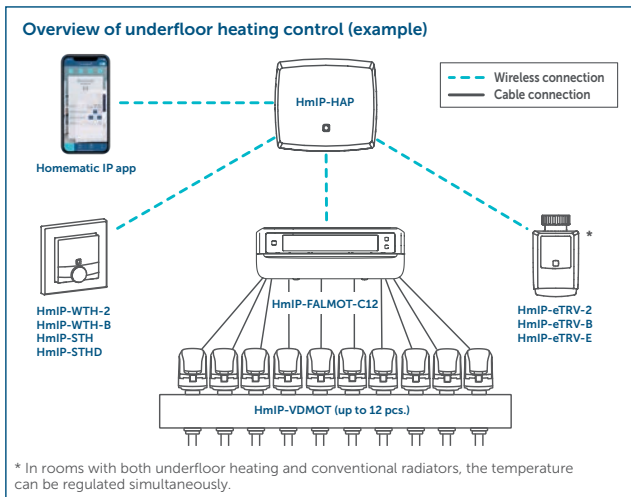

ENERGY-EFFICIENT CONTROL

The smart valve drive from Homematic IP ensures efficient floor heating. The climate is regulated simply and easily through infinitely variable heating valve control via the valve drive.

Precisely regulating the valve position allows the heating water flow rate to be infinitely adjusted. As a result, the heating system is used efficiently, and the temperature is controlled precisely.

Instead of the usual 3 to 5 W per heating circuit, the infinitely variable control consumes only 0.2 W for temperature control in the entire house.*

Operation requires connection to one of the following solutions:

- Stand-alone used with the Homematic IP Floor Heating Controller – 12 channels, motorised (no Access Point or Central Control Unit, configuration directly on the wall thermostat)
- Homematic IP Access Point with free smartphone app and free cloud service
- Third-party partner solutions

TECHNICAL SPECIFICATIONS

Supply voltage	3.3 VDC, SELV
Current consumption	120 mA max.
Degree of protection	IP20
Ambient temperature	0 to 50° C
Dimensions (W x H x D)	44 x 54 x 50 mm (without connecting cable)
Weight	80 g
Connection cable length	90 cm
Connection	M30 x 1.5 mm

SMART AND SIMPLE RETROFITTING

Existing floor heating systems can be easily retrofitted. The valve must be used together with a Homematic IP Floor Heating Controller – 12 channels, motorised (HmIP-FALMOT-C12). For a perfectly controlled indoor climate, the system can also be retrofitted with the Homematic IP Wall Thermostat.

FLEXIBLE USE

Using the VA 80 adapter supplied, the valve drive can be used on heating valves with a thread size of M30 x 1.5 mm from the most popular manufacturers (e.g. Heimeier, MNG, Junkers, Honeywell-Braukmann, Oventrop, Comap and Schlösser). If required, a valve adapter can be fitted for valve sizes from other manufacturers.

EASY INSTALLATION

Thanks to the practical snap-on connector, no tools are needed to install the valve drive.

If necessary, valve compatibility can be easily checked using the valve template (which you can find in the download area of www.homematic-ip.com).

BENEFITS AT A GLANCE

- ✓ No manual hydraulic balancing of the individual heating circuits necessary
- ✓ Energy-efficient operation without permanent power consumption
- ✓ Optimum control of the floor heating when used with the motorised floor heating controller (HmIP-FALMOT-C12) and a wall thermostat (HmIP-WTH-2)
- ✓ Simple installation with no need for tools

* Fraunhofer Institute: Evaluation measurement campaign FALMOT, 26/02/2019





LOGISTICS DATA

Product reference	153309A0
EAN code	4047976533091
Short description	HmIP-VDMOT
Packing unit	60
Packing dimensions	122 x 112 x 73 mm
Weight incl. packaging	165.4 g

PACKAGE CONTENTS

Homematic IP Valve Drive – motorised
 Valve adapter VA 80 (thread size M30 x 1.5 mm)
 Operating manual

Comparison of Homematic IP Floor Heating Controllers

Comparison criteria	Floor Heating Controller – 12 channels, motorised	Floor Heating Actuator – 10 channels 230 V
Short description	HmIP-FALMOT-C12	HmIP-FAL230-C10
Product image		
Required actuator	Valve drive – motorised (Valve adapter included in scope of delivery) 	Valve drive 230 V 
Functionality	Stepless and continuous control via motorised valve drive	PWM control (open/close) via thermal valve drives
Energy cost savings due to modern actuators	✓	No
Additional transformer required	No	No
Number of heating zones	12	10
Max. number of actuators	12	15 (14, if a pump is being operated)*
Control of circulating pump possible	✓ (in combination with HmIP-MIOB und HmIP-WHS2)	✓
Cooling mode possible	✓	✓
Supply voltage	230 V/50 Hz or 24 VDC/SELV	230 V/50 Hz
Current consumption	500 mA max. or 375 mA max. (at 24 VDC/SELV)	6,3 A max.
Switching capacity per heating zone	-	1 A max.
Nominal load of all actuators	-	250 W max.
Cable type and cross section	rigid and flexible cable, 0,12-0,5 mm ²	rigid and flexible cable, 0,75-1,5 mm ²
Connection type of the actuators	via plug connections	via Push-in clamps
Dimensions (W x H x D)	242 x 85 x 52 mm	242 x 85 x 52 mm
Weight	440 g	566 g
Typical radio free-field range	320 m	270 m
Radio frequency band	868,0-868,6 MHz 869,4-869,65 MHz	868,0-868,6 MHz 869,4-869,65 MHz
Display	✓ Illuminated LC-Display	No
Cloud operation with access point supported	✓	✓
Local operation with CCU3 supported	✓	✓
Stand-alone operation supported	✓ In combination with the wall thermostat WTH-B (WTH-B without Change Over function)	✓ In combination with the wall thermostat WTH-B (WTH-B without Change Over function)
Operation on the device supported	✓ (for installation and test purposes)	✓ (for installation and test purposes)
Number of heating profiles	3	3
Compatible with Amazon Alexa	✓	✓
Compatible with Google Assistant	✓	✓

* For connecting two heating circuits to one heating zone, every second heating zone is provided with double clamping points.

Switching Actuator for heating systems – 2 channels

HmIP-WHS2



homematic IP
Smart living. Simply exciting.



The Homematic IP Switching Actuator enables the intelligent and energy-efficient switching of circulation pumps, boilers, electric radiators and other electrical loads with a maximum output power of 3680 W.

FLEXIBLE APPLICATION OPTIONS

Universal switch actuator for switching circulation pumps, boilers, electric radiators and other electrical consumers via two channels.

Furthermore, the switch actuator is also suitable as a heat demand relay for controlling circulation pumps in conjunction with Homematic IP radiator thermostats or underfloor heating controllers..

The change-over relay enables the heating system to be easily switched from heating to cooling.

SIMPLE INSTALLATION

Installation in the required mounting position is very simple using the screws and dowels provided.

TECHNICAL SPECIFICATIONS

Supply voltage	230 V/50 Hz
Current consumption	16 A max.
Power consumption in standby	< 0.2 W
Load type	Ohmic load
Max. switching capacity	
Switching channel 1:	3680 W
Switching channel 2:	1150 W
Relay	
Changeover contact:	1-pole, μ contact
NO contact:	1-pole, μ contact
Degree of protection	IP20
Ambient temperature	0 to 50 °C
Dimensions (W x H x D)	120 x 130 x 30 mm
Weight	165 g
Radio frequency band	868.0-868.6 MHz 869.4-869.65 MHz
Typical range in open space	250 m

FEEL-GOOD TEMPERATURES ANYTIME

Smart switching of the central heating enables demand-based heat regulation for more efficient use of the heating energy. This saves not only valuable energy, but also costs.

Thanks to the integrated time profile, periods for hot water supply (each day in the morning and evening for example) can be easily and conveniently set up via the Homematic IP app.

Operation requires connection to one of the following solutions:

- Homematic IP access point with free smartphone app and free cloud service
- CCU3 central control unit with WebUI local user interface
- Third-party partner solutions

LOGISTICS DATA

Product reference	150842A0
EAN code	4047976508426
Short description	HmIP-WHS2
Packing unit	48
Packing dimensions	184 x 140 x 48 mm
Weight incl. packaging	311.8 g

PACKAGE CONTENTS

Homematic IP Switch Actuator for heating systems – 2 channels
Mounting material (4x screws, 4x plugs)
Operating manual

**SAVES ENERGY,
INCREASES YOUR
SECURITY**

Window and Door Contact – optical

HmIP-SWDO-2 | HmIP-SWDO-A

The compact sensor immediately detects opening or closing of windows and doors via an integrated infra-red light barrier. Reliable monitoring of windows secures the home while saving valuable energy during ventilation, as the room temperature is reduced automatically.



Available in white and anthracite

homematic 
Smart Living, Simply Exciting.

SMART MONITORING FOR A SECURE HOME

Opening and closing of windows and doors is detected immediately and displayed via the Homematic IP app. In addition, your home becomes even more secure with a Homematic IP Alarm Siren (e.g. HmIP-ASIR-2). If a window or door is opened, a loud alarm sound will be triggered automatically.

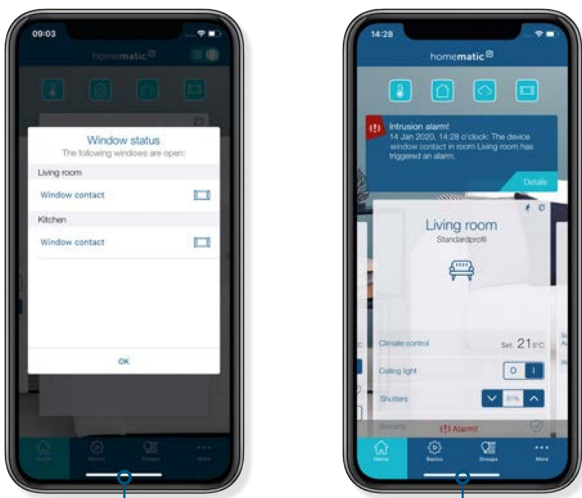

Shows open windows or doors and alarm messages in the Homematic IP App

To enable operation, the device has to be connected with one of the following solutions:

- Homematic IP Access Point with free smartphone app and free cloud service
- Third-party solutions of partners

TECHNICAL SPECIFICATIONS

Supply voltage	1x 1.5 V LR03/micro/AAA
Current consumption	100 mA max.
Battery life	2 years (typ.)
Degree of protection	IP20
Ambient temperature	5 to 35 °C
Dimensions (W x H x D)	102 x 15 x 20 mm
Weight	30 g (incl. batteries)
Radio frequency	868.0-868.6 MHz 869.4-869.65 MHz
Typical open area RF range	300 m

FRESH AIR BUT NO WASTE OF ENERGY

In connection with the Homematic IP Radiator Thermostat, the temperature in the room is automatically reduced if windows are opened for ventilation. The lowering temperature can even be defined by the user. The individual comfort temperature is automatically set as soon as the window is closed.

EVERYTHING IN SIGHT

The Homematic IP app gives a current overview of windows and doors in the smart home, providing for a secure feeling when you leave home or while being on the move.

ADAPTS TO THE WINDOW FRAME

The supplied white and brown caps allow the contact to be visually adapted to the window or door.

FAST AND EASY INSTALLATION

The mounting material included in the scope of delivery allows the contact to be fixed either with screws or adhesive strips. Thanks to residue-free removal of the adhesive strip, the window contact is even suitable for rented property.

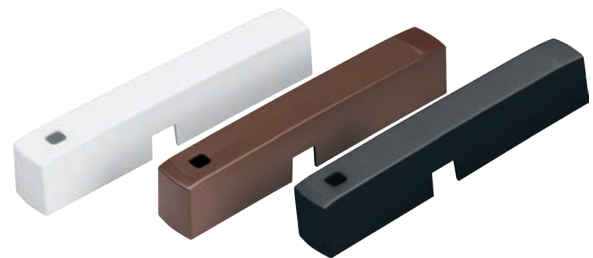

Colour variants in white, brown and anthracite

LOGISTICAL DATA

Version	White	Anthracite
Product reference	157857A0	160027A0
EAN code	4047976578573	4047976600274
Short description	HmIP-SWDO-2	HmIP-SWDO-A
Packing unit	144	144
Packing dimensions	122 x 93 x 36 mm	122 x 93 x 36 mm
Weight incl. packaging	116,7 g	116,7 g

PACKAGE CONTENTS

Homematic IP Window / Door Contact – optical
 Caps: White (incl. brown) | Anthracite
 Double-sided adhesive strips
 Countersunk head screws 2.2 x 13 mm (2x)
 Reflecting sticker (for dark surfaces)
 1.5 V LR03/micro/AAA battery
 User manual

SAVE ENERGY,
INCREASE
YOUR SECURITY

Window / Door Contact with magnet

HmIP-SWDM-2

The window / door contact immediately detects opening and closing of windows and doors. Monitoring of windows secures the home while saving valuable energy during ventilation as the room temperature is reduced automatically.

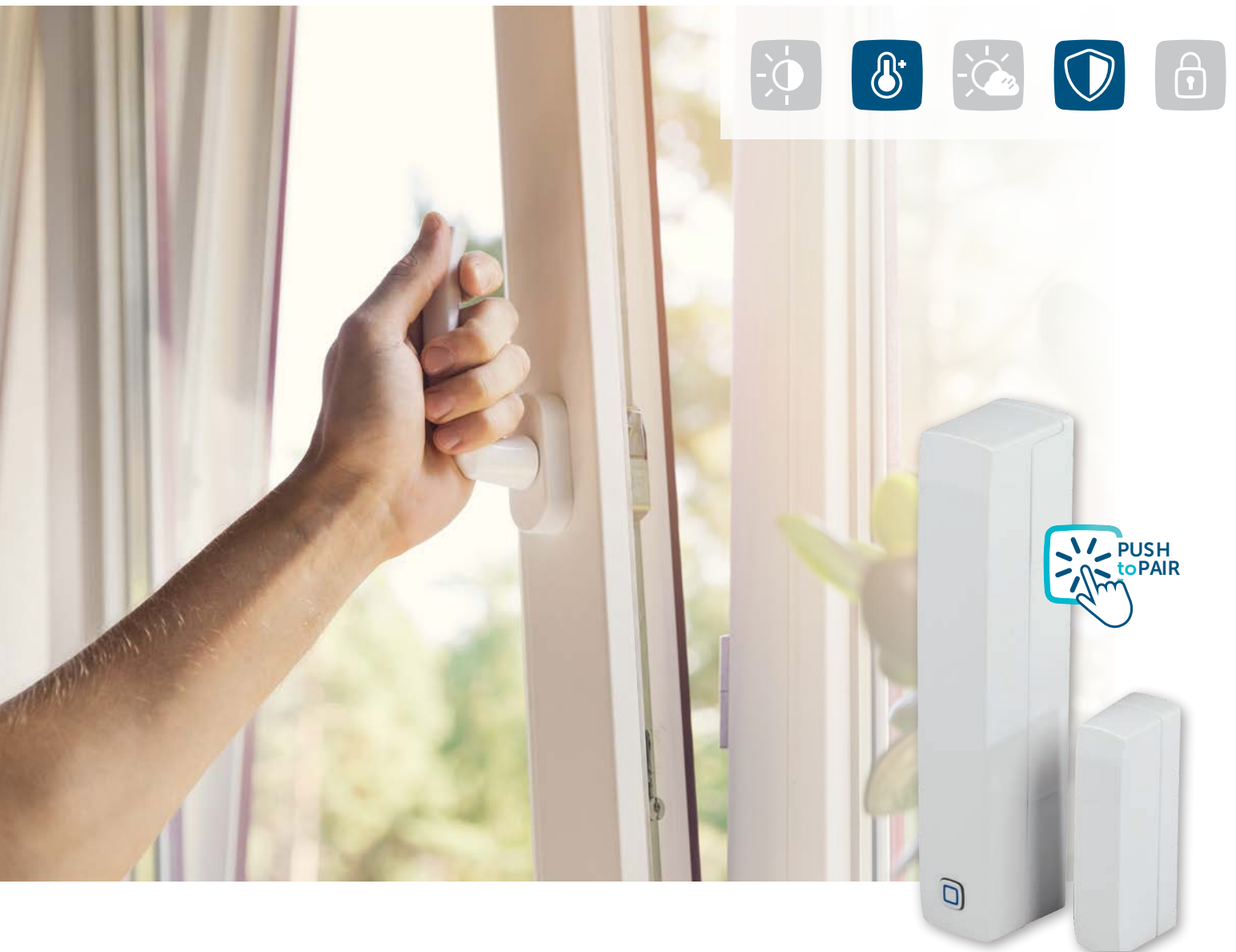

homematic ^{IP}
Smart Living, Simply Exciting.

SMART MONITORING FOR A SECURE HOME

Opening and closing of windows and doors is detected immediately and displayed via the Homematic IP app. In addition, your home becomes even more secure with a Homematic IP Alarm Siren (e.g. HmIP-ASIR-2): If a window or door is opened, a loud alarm sound will be triggered automatically.

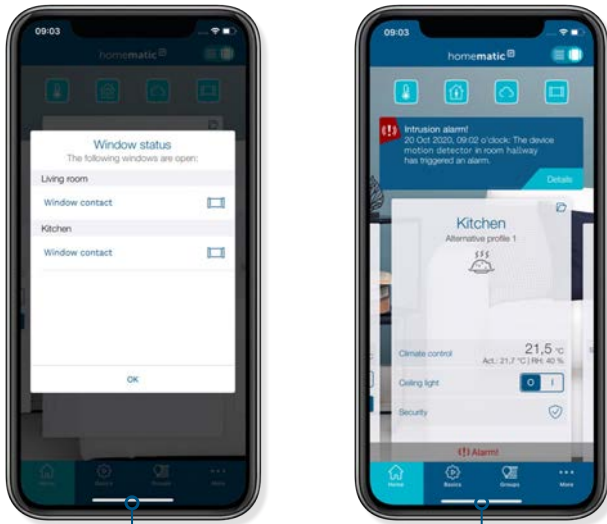

Shows open windows or doors and alarm messages in the Homematic IP app

To enable operation, the device has to be connected with one of the following solutions:

- Stand-alone (push-to-pair)
- Homematic IP Access Point with free smartphone app and free cloud service
- Third-party solutions of partners

FRESH AIR BUT NO WASTE OF ENERGY

In connection with the Homematic IP Radiator Thermostat, the temperature in the room is automatically reduced if windows are opened for ventilation. The lowering temperature can even be defined by the user. The individual comfort temperature is automatically set as soon as the window is closed.

EVERYTHING IN SIGHT WHEN LEAVING THE HOUSE

The Homematic IP app gives a current overview of windows and doors in the smart home, providing for a secure feeling when you leave home or while being on the move.

INDIVIDUAL CONFIGURATION

- ✓ Stand-alone operation (push-to-pair) with direct pairing of up to eight Homematic IP Radiator Thermostats – basic (HmIP-eTRV-B) for automatic lowering of the room temperature during ventilation.
- ✓ In combination with an Access Point, configuration and status display are carried out via the free Homematic IP smartphone app. This enables flexible combination with a variety of Homematic IP devices for enhanced functionality.

FAST AND EASY INSTALLATION

The mounting material included in the scope of delivery allows the contact and magnet to be fixed either with screws or adhesive strips. Thanks to residue-free removal of the adhesive strip, the window contact is even suitable for rented property.

TECHNICAL SPECIFICATIONS

Supply voltage	2x 1.5 V LR03/micro/AAA
Current consumption	35 mA max.
Battery life	4 years (typ.)
Degree of protection	IP20
Ambient temperature	-10 to +50°C
Dimensions electronic unit (W x H x D)	102 x 18 x 25 mm
Dimensions magnet contact (W x H x D)	48 x 11 x 13 mm
Weight electronic unit	46 g (including batteries)
Weight magnetic contact	17 g (including magnet)
Radio frequency band	868.0-868.6 MHz 869.4-869.65 MHz
Typ. open area RF range	200 m

LOGISTICAL DATA

Product reference	151363A0
EAN code	4047976513635
Short description	HmIP-SWDM-2
Packing unit	144
Packing dimensions	122 x 93 x 36 mm
Weight incl. packaging	138.0 g

PACKAGE CONTENTS

Homematic IP Window / Door Contact with magnet
Magnet contact and spacer
Double-sided adhesive strips (2x) and screws (4x)
1.5 V LR03/micro/AAA batteries (2x)
User manual

FEEL SAFE AND
SECURE IN YOUR
SMART HOME

Alarm Siren

HmIP-ASIR-2

The Homematic IP Alarm Siren helps scaring off potential burglars. With powerful 90 dB, the siren immediately triggers a loud signal tone in alarm cases and thus protects your home against unwanted intruders.

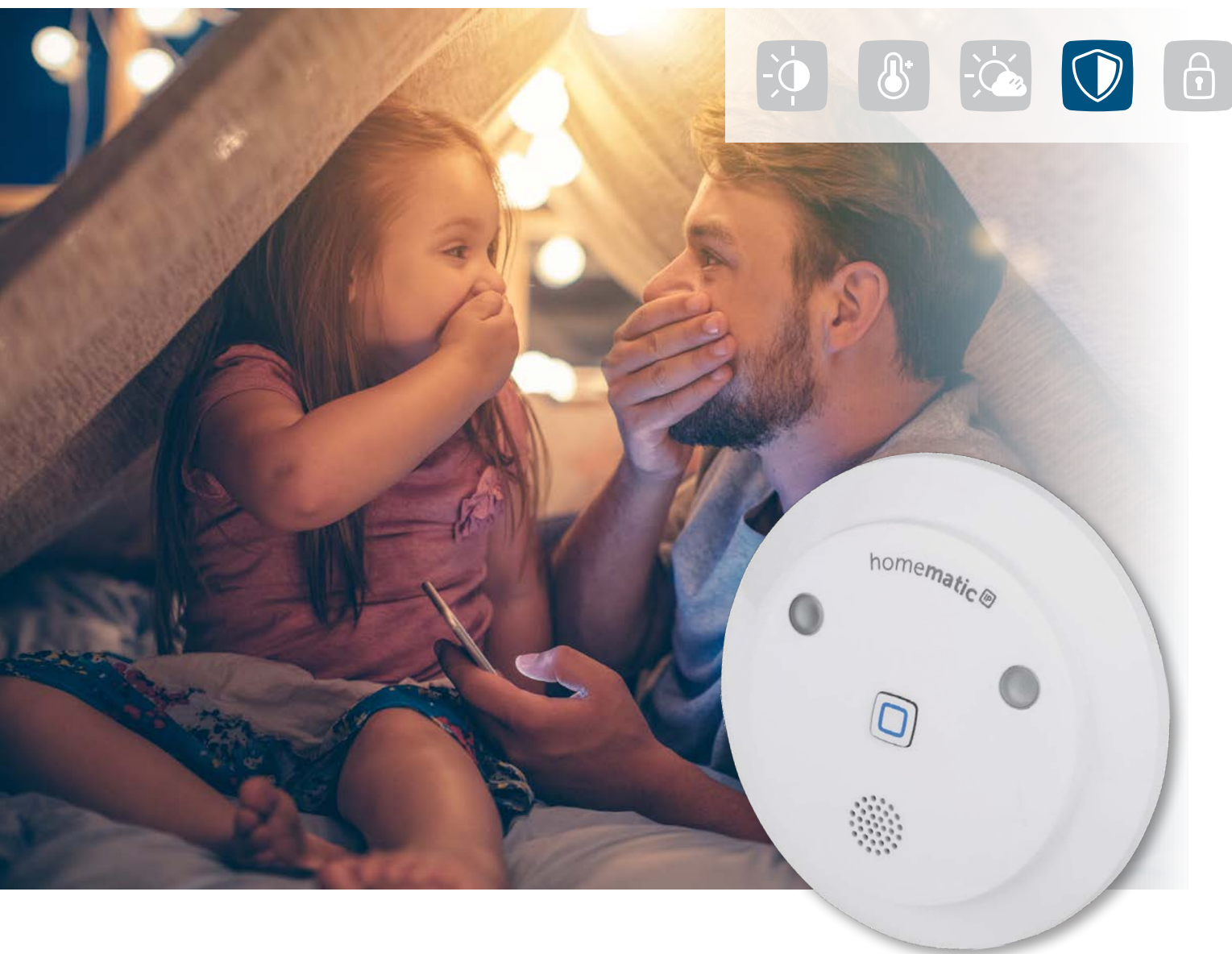

homematic ^{IP}
Smart Living, Simply Exciting.

CREATE A SECURE HOME WITH HOMEMATIC IP

If motion is detected in the house, by a motion detector or window sensor for example, loud signal sounds and two bright red LED lights make sure that you are immediately warned.

At the same time, the Homematic IP app informs users via push notification if something is wrong at home.

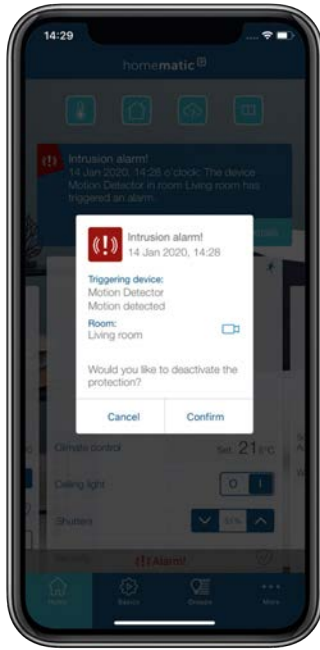

To enable operation, the device has to be connected with one of the following solutions:

- Homematic IP Access Point with free smartphone app and free cloud service
- Third-party solutions of partners

FAIL-SAFE AND RELIABLE

Alarms are triggered even without Internet or cloud connection thanks to direct communication between the devices. Even if the Access Point is destroyed, by a burglar for example, the alarm siren remains active.

EVERYTHING IN SIGHT

The Homematic IP app provides a current overview of the smart home to ensure a secure feeling even when you are on the move. The integration of a Smartfrog camera additionally increases the security and always provides an up-to-date overview of your home.

COMFORTABLE VOICE CONTROL

In addition to operation by push-button, remote control or app, the desired alarm mode (absence or presence mode) can be activated (not deactivated) by voice command using Amazon Alexa or Google Assistant.

FLEXIBLE MOUNTING WITHOUT CABLING

Thanks to battery operation, the device is easily mounted at any location. This allows the alarm siren to be conveniently mounted out of the reach of a burglar. Since the siren has been designed similar to a smoke alarm, the alarm siren adapts to the living environment of your home. In case of disassembly, the sabotage contact triggers an alarm and thus ensures additional security.

INDIVIDUAL ALARM SOUNDS

The acoustic and the optical alarm signal as well as the alarm duration can be adjusted via the app. The alarm siren can also be used in conjunction with a Homematic IP Smoke Alarm. In the event of fire, the alarm sound is additionally emitted via the alarm siren.

TECHNICAL SPECIFICATIONS

Supply voltage	3x 1.5 V LR6/mignon/AA
Battery life	2 years (typ.)
Degree of protection	IP20
Ambient temperature	5 to 35 °C
Dimensions (ø x H)	124 x 45 mm
Weight	190 g (including batteries)
Radio frequency band	868.0-868.6 MHz / 869.4-869.65 MHz
Typical open area RF range	250 m

LOGISTICAL DATA

Product reference	153825A0
EAN code	4047976538256
Short description	HmlIP-ASIR-2
Packing unit	32
Packing dimensions	184 x 140 x 73 mm
Weight incl. packaging	349.0 g

PACKAGE CONTENTS

Homematic IP Alarm Siren
 Ceiling bracket
 1.5 V LR6/mignon/AA batteries (3x)
 Mounting material (2x screws and 2x plugs)
 User manual

SECURE SOLUTION
FOR OUTDOOR
AREAS

Alarm Siren – outdoor

HmlP-ASIR-O

Increase your security: The reliable and tamper-proof alarm siren with weatherproof housing offers reliable warning in case of danger. Loud signal tones and bright LED signal lights help scaring off potential burglars. And what's more: The solar cell stores enough energy to enable independent operation.



homematic ^{IP}
Smart Living, Simply Exciting.

CREATE A SECURE HOME WITH HOMEMATIC IP

If motion is detected in the house, by a motion detector or window sensor for example, loud signal sounds (100 dB) and bright LED lights make sure that you are immediately warned. In this way, burglars are deterred and neighbours are made aware at the same time.

Furthermore, the Homematic IP app informs users via push notification if something is wrong at home.

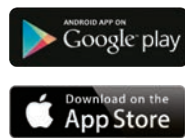
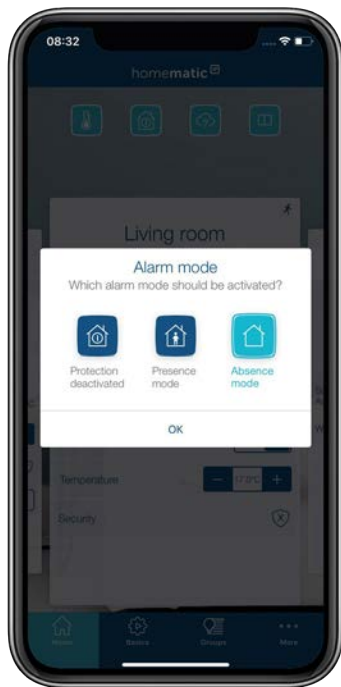

To enable operation, the device has to be connected with one of the following solutions:

- Homematic IP Access Point with free smartphone app and free cloud service
- Third-party solutions of partners

SUSTAINABLE POWER SUPPLY

Power supply is self-sufficient and sustainable via a high-performance solar cell. Therefore, the siren requires low maintenance effort and offers flexible application.

In connection with three rechargeable NiMH batteries sufficient energy is saved for reliable operation even at night or during cloudy days. If necessary, the battery pack can be charged via micro USB port.

FAIL-SAFE AND RELIABLE

Alarms are triggered even without Internet or cloud connection due to direct communication between the devices. Even if the Access Point is destroyed, by a burglar for example, the alarm siren remains active.

EVERYTHING IN SIGHT

The Homematic IP app provides a current overview of the smart home to ensure a secure feeling even when you are on the move. The integration of a Smartfrog camera additionally increases the security and always provides an up-to-date overview of your home.

FLEXIBLE MOUNTING WITHOUT CABLING

Operation via the solar cell and the weatherproof housing (IP44) offer installation of the device at any outdoor location. This allows the alarm siren to be mounted clearly visible to the street, for example, and out of the reach of a burglar. If necessary, the sabotage contact reports any manipulation or disassembly and provides additional security.

INDIVIDUAL ALARM SOUNDS

The acoustic and the optical alarm signal as well as the alarm duration can be individually selected via the app.

TECHNICAL SPECIFICATIONS

Supply voltage	Solar cell + battery pack, NiMH, 3,6 V, 1200 mAh (3x 1,2 V HR6/ Mignon/AA)
External load voltage	5 VDC/500 mA
Current consumption	500 mA max.
Degree of protection	IP44
Ambient temperature	-20 to +50 °C
Dimensions (W x H x D)	110 x 230 x 87 mm
Weight	755 g (including battery)
Radio frequency band	868.0-868.6 MHz 869.4-869.65 MHz
Typ. open area RF range	300 m
Volume Piezo loudspeaker	100 dB (at a distance of 1 meter)

LOGISTICAL DATA

Product reference	153208A0
EAN code	4047976532087
Short description	HmlP-ASIR-O
Packing unit	8
Packing dimensions	280 x 185 x 147 mm
Weight incl. packaging	1190.6 g

PACKAGE CONTENTS

Homematic IP Alarm Siren – outdoor
Mounting accessories
User manual

IMMEDIATELY
INFORMS IF
WATER LEAKS

Water Sensor

HmlP-SWD

Reliable water sensor for additional security in your smart home: As soon as humidity or water touches the sensor, a loud alarm sound is triggered via the integrated siren. In addition, an alarm message is indicated via smartphone. This allows early intervention at any time to prevent major water damage.



homematic ^{IP}
Smart Living, Simply Exciting.

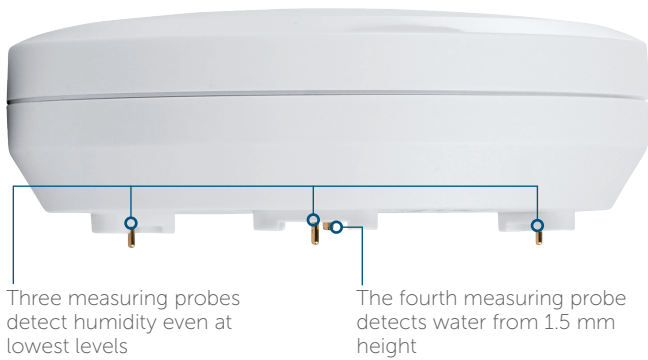

EARLY DETECTION OF WATER LEAKS

If water or moisture is detected, caused by a defective washing machine for example, the water sensor immediately triggers an alarm: The integrated siren provides for a loud alarm in the house. And in case no one is at home, an alarm message is also sent to the users' smartphone. This allows immediate action to be taken to keep water damage to a minimum.

ALARM ANYWHERE IN THE HOUSE

In addition, your home becomes even more secure with a Homematic IP Alarm Siren (e.g. HmlIP-ASIR-2). If water or humidity are detected, a loud alarm sound is also triggered via the alarm siren.

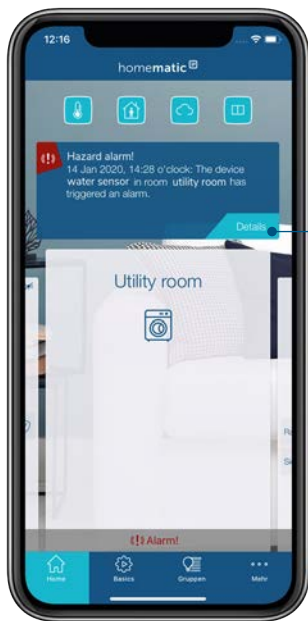

Alarm via push notification in the Homematic IP app



PROTECT YOUR SMART HOME

The Homematic IP app provides a current overview of the smart home to ensure a secure feeling even when you are on the move. In case of water leaks, you will be immediately informed via push-notification and the Homematic IP app. With an integrated tilt sensor, movements or manipulation of the water sensor do not go unnoticed and will be indicated immediately.

IMMEDIATELY READY FOR USE

The water sensor can be placed at any location, next to the washing machine for example. It offers detection of humidity on different surfaces and adapts flexibly even to inclined grounds thanks to its spring-mounted measuring probes.

INDIVIDUAL TRIGGERING BEHAVIOUR

The alarm sound and duration can be individually selected. You can also define, whether the sensor should trigger in the event of moisture and/or water.

To enable operation, the device has to be connected with one of the following solutions:

- Homematic IP Access Point with free smartphone app and free cloud service
- Central Control Unit CCU2/CCU3 with the local user interface WebUI
- Third-party solutions of partners

TECHNICAL SPECIFICATIONS

Supply voltage	2x 1.5 V LR03/micro/AAA
Battery life	5 years (typ.)
Degree of protection	IP44
Ambient temperature	-20 to +55 °C
Dimensions (W x H x D)	80 x 80 x 30 mm
Weight	78.2 g (including batteries)
Radio frequency band	868.0-868.6 MHz 869.4-869.65 MHz
Typ. open area RF range	230 m
Volume integrated siren	approx. 77 dB (at a distance of 1 meter)

LOGISTICAL DATA

Product reference	151694A0
EAN code	4047976516940
Short description	HmlIP-SWD
Packing unit	90
Packing dimensions	122 x 112 x 48 mm
Weight incl. packaging	154.2 g

PACKAGE CONTENTS

Homematic IP Water Sensor
1.5 V LR03/micro/AAA batteries (2x)
User manual

DETECTS EVERY
MOVEMENT FOR
MORE CONVENIENCE
AND SECURITY

Motion Detector with Brightness Sensor – indoor

HmIP-SMI

No movement goes unnoticed: The smart sensor monitors your home and immediately triggers an alarm or switches lights on as soon as motion is detected.



homematic ^{IP}
Smart Living, Simply Exciting.

ALL THE INFORMATION AT A GLANCE

The Homematic IP app provides a current overview of the smart home to ensure a secure feeling even when you are on the move. If motion is detected while the protection mode is activated, a push-notification is sent to the users' smartphone immediately. Also, an alarm message is displayed in the app. In addition, your home becomes even more secure with a Homematic IP Alarm Siren (e.g. HmIP-ASIR-2) as a loud alarm sound will be triggered. A warning is also given via the Homematic IP app in case the device is removed.

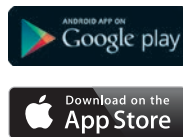
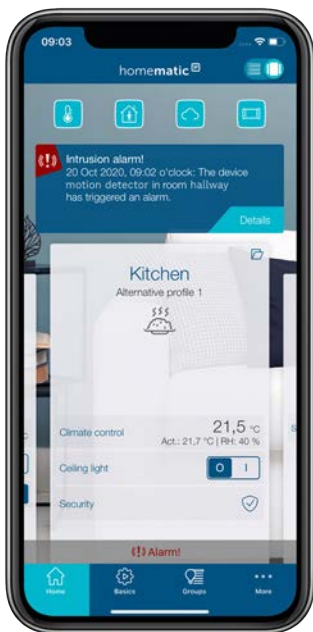

To enable operation, the device has to be connected with one of the following solutions:

- Homematic IP Access Point with free smartphone app and free cloud service
- Third-party solutions of partners

TECHNICAL SPECIFICATIONS

Supply voltage	2x 1.5 V LR6/mignon/AA
Current consumption	40 mA
Battery life	3 years (typ.)
Detection range	12 m
Detection angle	105°
Degree of protection	IP20
Ambient temperature	5 to 35 °C
Dimensions (W x H x D)	52 x 65 x 34 mm
Weight	85 g (including batteries)
Radio frequency band	868.0-868.6 MHz 869.4-869.65 MHz
Typ. open area RF range	280 m

SMART LIGHT CONTROL

The light is automatically switched on for the set duration. With the integrated twilight sensor, the brightness level for switching the lights on can be individually defined. Both the brightness value as well as the switch-on time can be set individually via the Homematic IP app.

POWERFUL SENSOR

The high-performance sensor with a detection range of up to 12 m and a detection angle of up to 105° immediately detects movements, ensuring smart and reliable motoring in the smart home.

SMALL AND COMPACT

The compact design makes the device ideal for indoor application. It can be flexibly mounted either on walls, ceilings or in corners. With the included stand, the motion sensor is placed anywhere in the smart home.

FAIL-SAFE AND RELIABLE

Alarms are triggered even without Internet or cloud connection due to direct communication between the devices. Even if the Access Point is destroyed, by a burglar for example, the other devices remain active.

LOGISTICAL DATA

Product reference	142722A0
EAN code	4047976427222
Short description	HmIP-SMI
Packing unit	90
Packing dimensions	122 x 112 x 48 mm
Weight incl. packaging	177.5 g

PACKAGE CONTENTS

Homematic IP Motion Detector with Brightness Sensor – indoor
Wall mounting bracket
Stand
Mounting accessories
1.5 V LR6/mignon/AA batteries (2x)
User manual

ADDITIONAL
SECURITY & COMFORT
FOR OUTDOOR AREAS

Motion Detector with Brightness Sensor – outdoor

HmIP-SMO-2 | HmIP-SMO-A-2

You will never be left in the dark: The reliable motion detector with weatherproof housing and extra-long battery lifetime monitors the outdoor area, switches lights on or triggers an alarm when motion is detected. The flexible and compact housing design allows the sensor to be individually adapted to the surrounding.



Available in white and anthracite

homematic ^{IP}
Smart Living, Simply Exciting.

POWERFUL DURING THE DAY AND NIGHT

The high-performance lens with a detection range of up to 12 m immediately detects movements, ensuring smart and reliable motoring of outdoor areas. The 360° rotating sensor allows for exact monitoring of desired areas.

The integrated brightness sensor makes precise switching of lights possible, no matter if in the dark or at dusk. Even on cloudy days the sensor can exactly differentiate the brightness values. Brief changes in the level of brightness are filtered out.

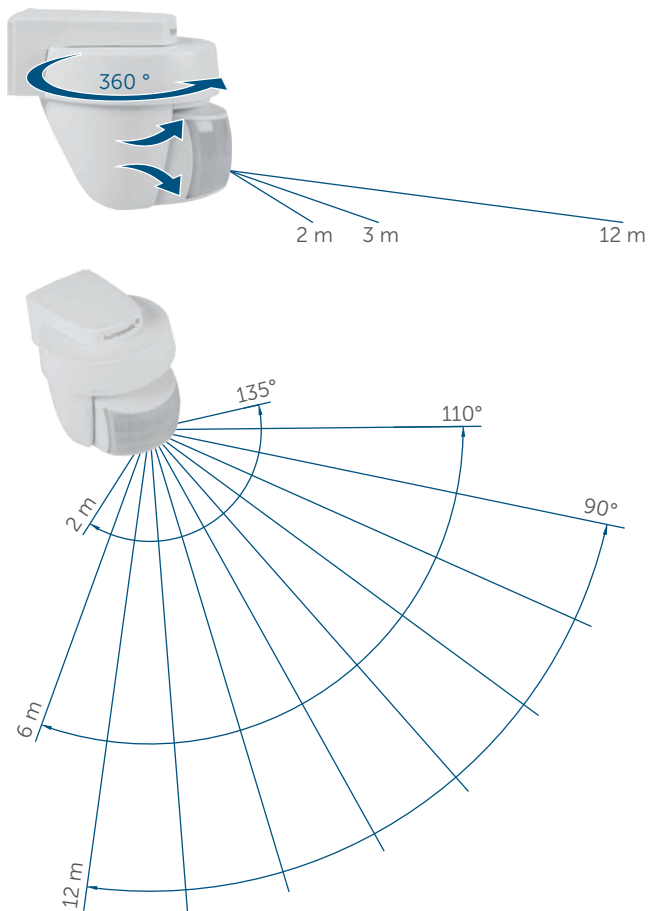

ALL THE INFORMATION AT A GLANCE

The Homematic IP app provides a current overview of the smart home to ensure a secure feeling even when you are on the move. If motion is detected while the protection mode is activated, a push-notification is sent to the users' smartphone immediately. Also, an alarm message is displayed via app.

FLEXIBLE MOUNTING WITHOUT CABLING

Battery operation and radio communication offer installation of the device at any installation site. Thanks to the wide temperature range of -20 to +55 °C and the weatherproof housing (IP44), the motion detector offers installation in outdoor areas or garages, for example.

FAIL-SAFE AND RELIABLE

Alarms are triggered even without Internet or cloud connection due direct communication between the devices. Even if the Access Point is destroyed, by a burglar for example, the other devices remain active.

EXTRA-LONG BATTERY LIFE

With two mignon-batteries, a battery life of typically 6 years is achieved, offering low-maintenance work for the device.

ADJUSTMENT OF TRIGGERING BEHAVIOUR

Both the brightness values as well as the switch-on time can be set individually via the Homematic IP app.

To enable operation, the device has to be connected with one of the following solutions:

- Homematic IP Access Point with free smartphone app and free cloud service
- Third-party solutions of partners

TECHNICAL SPECIFICATIONS

Supply voltage	2x 1.5 V LR6/mignon/AA
Current consumption	40 mA max.
Battery life	6 years (typ.)
Degree of protection	IP44
Ambient temperature	-20 to +55 °C
Dimensions (W x H x D)	76 x 74 x 90 mm
Weight	170 g (including batteries)
Radio frequency band	868.0-868.6 MHz 869.4-869.65 MHz
Typ. open area RF range	230 m
Detection range	12 m
Detection angle horizontal	90°

LOGISTICAL DATA

Version	White	Anthracite
Product reference	156203A0	156227A0
EAN code	4047976562039	4047976562275
Short description	HmIP-SMO-2	HmIP-SMO-A-2
Packing unit	45	45
Packing dimensions	122 x 112 x 97 mm	122 x 112 x 97 mm
Weight incl. packaging	303.6 g	303.6 g

PACKAGE CONTENTS

Homematic IP Motion Detector with Brightness Sensor - outdoor
Screws (2x) and plugs (2x)
1.5 V LR6/mignon/AA batteries (2x)
User manual

LIGHTS ARE
SWITCHED ON
IF NEEDED

Presence Sensor – indoor

HmlIP-SPI

Detects if people are present by precise detection of the slightest movements in a 360° panoramic view for automatic light control and increased security in your smart home.



homematic ^{IP}
Smart Living, Simply Exciting.

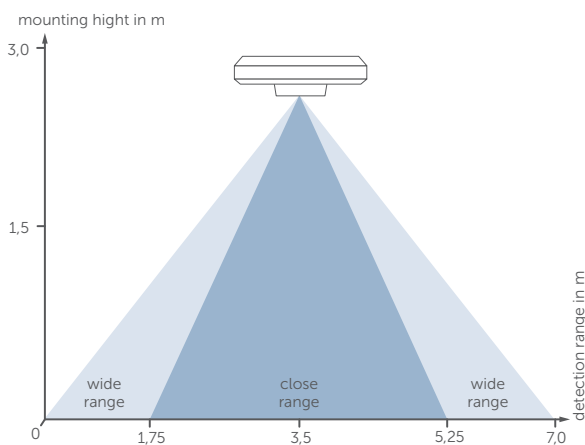

Operation requires connection to one of the following solutions:

- Homematic IP Access Point with free smartphone app and free cloud service
- Third-party solutions of partners

STRONG PERFORMANCE

The high-resolution sensor detects movements in a range of up to 7 m. The powerful lens precisely detects even the slightest movements, such as typing on a keyboard.

SWITCHES LIGHTS ON IF NEEDED

Lights are switched on automatically if a person is present. If no movement is detected, the light is switched off again. The integrated brightness sensor also monitors the ambient brightness, switching off the lights as soon as the room is bright enough.

SECURE MONITORING FOR INCREASED PROTECTION

The sensitive sensor reliably monitors a room and provides a loud alarm in conjunction with an alarm siren (e.g. HmIP-ASIR-2) in the event of a break-in, for example. With its modern design, the sensor fits inconspicuously into the living area.

ADJUSTMENT OF BRIGHTNESS

Unlike conventional sensors, the automatic temperature compensation of the presence sensor offers the advantage that a continuous sensor sensitivity is always given. This ensures precise presence detection in a room even in case of increased surface temperatures (when using a floor heating, for example).

FLEXIBLE MOUNTING THANKS TO BATTERY OPERATION

Supplied screws and plugs enable flexible installation on the ceiling. Two mignon batteries are used for the power supply, which supply the presence sensor with energy for up to two years (typical).

TECHNICAL SPECIFICATIONS

Supply voltage	2 x 1.5 V LR6/Mignon/AA
Battery life	2 years (typ.)
Degree of protection	IP20
Ambient temperature	5 to 35 °C
Dimensions (ø x H)	100 x 29 mm
Weight	119 g (including batteries)
Radio frequency band	868.0-868.6 MHz 869.4-869.65 MHz
Typ. open area RF range	250 m
Detection range	7 m
Detection angle	105 °

LOGISTICAL DATA

Product reference	150587A0
EAN code	4047976505876
Short description	HmIP-SPI
Packing unit	60
Packing dimensions	122 x 112 x 73 mm
Weight incl. packaging	239.1 g

PACKAGE CONTENTS

Homematic IP Presence Sensor – indoor
 Mounting plate and mounting material
 1.5 V LR6/mignon/AA batteries (2x)
 User manual

ALARM FUNCTIONS
ALWAYS TO HAND

Key Ring Remote Control – alarm

HmIP-KRCA

This practical key-ring remote control is the ideal accessory to operate your Homematic IP security solution smartly and conveniently. The desired alarm mode can be activated simply by pressing a button when coming home or leaving the house, and it can also switch the lights on.

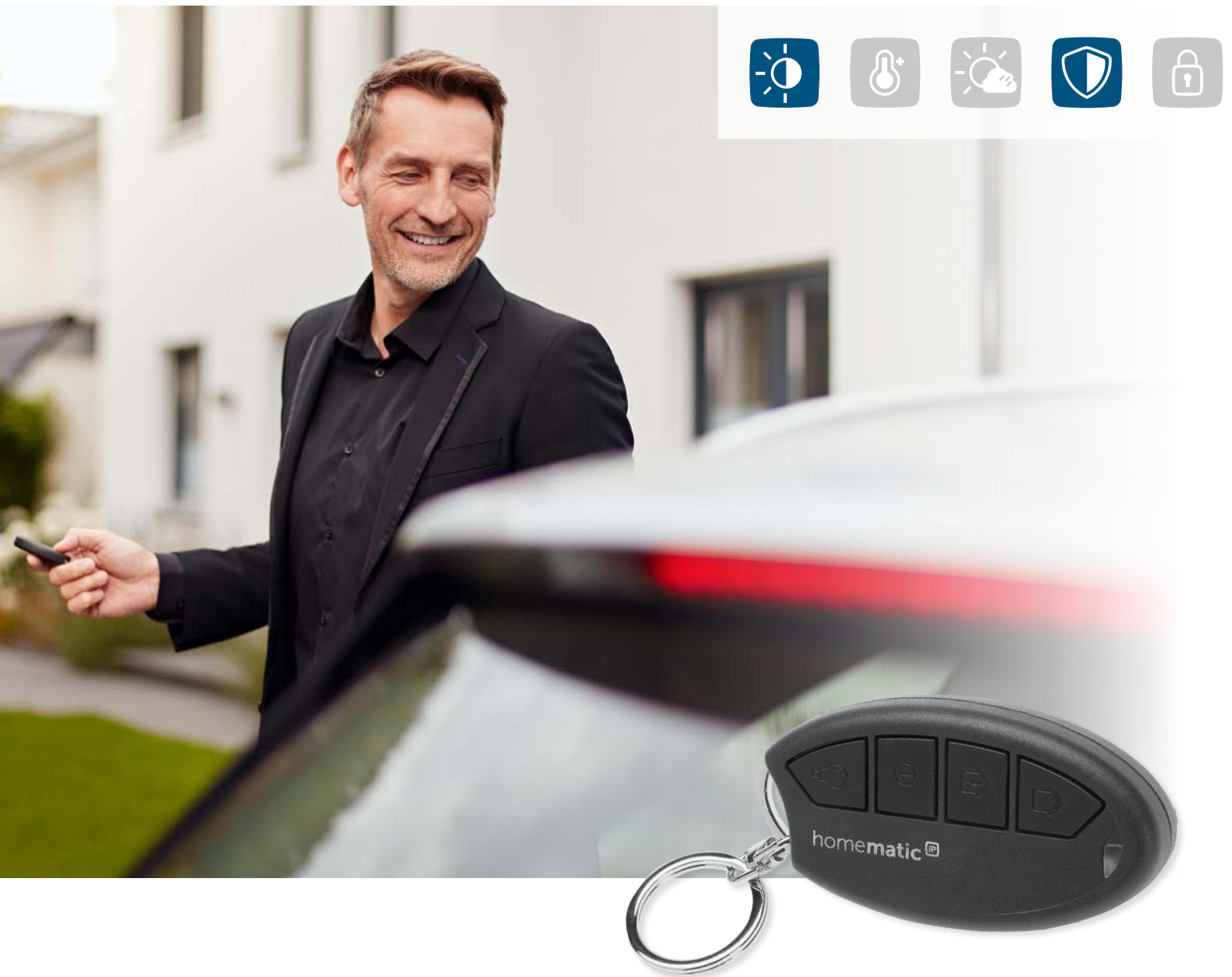

homematic ^{IP}
Smart living. Simply exciting.



SMART OPERATION FOR A SAFE, SECURE HOME

With the handy key ring remote control, the alarm modes "absence mode" "presence mode" and "protection deactivated" can be easily activated or deactivated at the touch of a button. The additional light button can be used to switch the lighting in the entrance area on or off, for example.

To enable operation, the device must be connected with one of the following solutions:

- Homematic IP Access Point with free smartphone app and free cloud service
- Third-party partner solutions

TECHNICAL SPECIFICATIONS

Supply voltage	1x 1.5 V LR03/micro/AAA
Battery life	2 years (typical)
Degree of protection	IP20
Ambient temperature	-10 to +55 °C
Dimensions (W x H x D)	38 x 75 x 14 mm
Weight	38 g (incl. batteries)
Radio frequency band	868.0–868.6 MHz/ 869.4–869.65 MHz
Typical radio free-field range	200 m

PRACTICAL REMOTE CONTROL FOR YOUR KEY RING

The compact design of this small remote control means it fits in any pocket – or on your key ring. So you can use it flexibly in the house, outside the house, or in the car on your way home. If you lose the remote control while out and about, it can be easily blocked via the app.

SECURITY THROUGH VISUAL FEEDBACK

When the "presence mode" or "absence mode" is activated, the status LED indicates whether activation is prevented by an open window, for example.

POWERFUL AND ROBUST

The remote control's particularly long range of up to 200 meters means you can deactivate the "presence mode" while still on your way to the door.

The housing is made of halogen-free, glass-fibre-reinforced plastic, making the remote control particularly robust, and its high temperature range means it can cope with any situation. Every button press is confirmed directly by the built-in status LED.

PARTICULARLY POWERFUL

It works reliably at an ambient temperature between -10 °C and +55 °C and can therefore cope with any day-to-day situation (e.g. being left in the car for a long time). Its particularly long range of up to 200 meters also makes it possible to switch on the outdoor lighting or open the garage door directly from your car, for example.

LOGISTICS DATA

Product reference	142562A0
EAN code	4047976425624
Short description	HmIP-KRCA
Packing unit	144
Packing dimensions	122 x 93 x 36 mm
Weight incl. packaging	100.5 g

PACKAGE CONTENTS

Homematic IP Key Ring Remote Control – alarm
Key ring
1.5 V LR03/micro/AAA battery
Operating manual

OPENS THE
DOOR TO THE
SMART HOME

Door Lock Drive

HmIP-DLD

No more searching for the key? The intelligent door lock drive by Homematic IP makes it possible! Unlocking, locking and opening of doors is done conveniently and securely via smartphone or remote control. The Homematic IP app keeps an eye on your entrance door at all times.



homematic ^{IP}
Smart Living, Simply Exciting.

CONVENIENT & FLEXIBLE ACCESS CONTROL

It is now possible to easily lock, unlock and even open doors at any time while on the move or from the couch. Simply by Homematic IP app or key ring remote control.

Another advantage: Secure locking of the door is also possible by voice control (with Amazon Alexa or Google Assistant).

EASILY DETERMINE WHO MAY ENTER YOUR HOME

Thanks to configurable access authorisations, access to your smart home can be managed individually – no matter for which day of the week or at what time. The front door can only be opened if you want it to. This means, for example, that cleaning staff or care services can enter the house only at certain times using the key ring remote control.

IS THE FRONT DOOR REALLY LOCKED?

Thanks to time-dependent locking, this question becomes unnecessary. At a defined time, the front door is automatically locked (e.g. at night). This not only increases the security in the smart home, but also saves you from having to check the front door when it is not necessary.

If you want to be on the safe side, you can have the front door automatically locked again after each time it is unlocked. Set-points and delay times can be set individually via the app.

HIGHLY SECURE

The door lock drive benefits from the VDE-certified protocol, IT and data security of the Homematic IP system.

As it is mounted on the inside of the door, the device is not visible from the outside.

Operation requires connection to one of the following solutions:

- Homematic IP Access Point (HmIP-HAP) with free smartphone app and free cloud service
- Third-party solutions of partners

TECHNICAL SPECIFICATIONS

Supply voltage	3x 1.5 V LR6/mignon/AA
Battery life	1/2 year (typ.)
Degree of protection	IP20
Ambient temperature	5 to 35 °C
Dimensions (W x H x D)	56 x 118 x 63 mm
Weight	328 g (including batteries)
Radio frequency band	868.0-868.60 MHz 869.4-869.65 MHz
Typ. open area RF range	200 m

EASY TO RETROFIT

Easily mounted on standard profile cylinders with emergency and danger function – without damaging the door, frame or key. Thanks to battery operation, no wiring is necessary. For mounting, the lock cylinder must protrude 8-15 mm on the inside of the door.



SUITABLE FOR UNIVERSAL USE

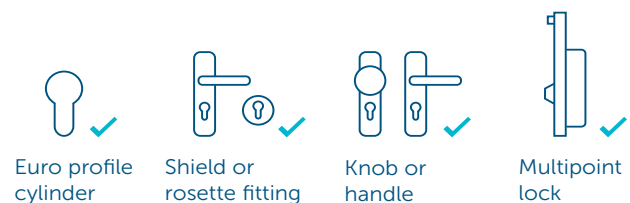

ADDITIONAL ADVANTAGES

- ✓ Up to 8 access authorisations with individual time profiles can be created for each door lock drive
- ✓ Manual opening and closing possible at any time via the rotary wheel (emergency function)
- ✓ The door can still be opened from the outside with a standard key
- ✓ Personal PINs to protect against unauthorised operation via app

LOGISTICAL DATA

Product reference	154952A0
EAN code	4047976549528
Short description	HmIP-DLD
Packing unit	30
Packing dimensions	184 x 112 x 97 mm
Weight incl. packaging	529.2 g

PACKAGE CONTENTS

Homematic IP Door Lock Drive
Mounting plate
Mounting material and batteries
User manual

SMART, SECURE
ACCESS
COMPLETELY KEY
FREE

Keypad

HmIP-WKP

With the Homematic IP Keypad, you can access your home at any time. The ability to set up multiple access codes with individual time profiles makes your smart home even more flexible. In addition, codes can be defined for controlling the light and your garage door.



homematic 
Smart living. Simply exciting.



EASY ACCESS WITH A NUMERICAL CODE

With the Homematic IP Keypad and door lock actuator, access to your smart home can be conveniently controlled with numerical codes. Once the code has been entered successfully and confirmed via the "Unlock" button, the door lock actuator automatically unlocks the front door. The front door can be locked in the same way when you leave the house.

In addition, the alarm modes can be easily and simply activated or deactivated with a numerical code, so that, for example, you can activate absence mode when you leave.

In addition, the integrated proximity sensor ensures the keypad is automatically illuminated when someone approaches.

Operation requires connection to one of the following solutions:

- Homematic IP access point with free smartphone app and free cloud service
- Third-party partner solutions

TECHNICAL SPECIFICATIONS

Supply voltage	2x 1.5 V LR03/micro/AAA
Battery life	2 years (typical)
Degree of protection	IP44
Ambient temperature	-20 to +55 °C
Dimensions (W x H x D)	71 x 161 x 29 mm
Weight	137 g (including batteries)
Radio frequency band	868.0–868.6 MHz 869.4–869.65 MHz
Typical range in open space	200 m

OPTIMALLY CONFIGURED VIA THE HOMEMATIC IP APP

Using the Homematic IP app, you can configure up to eight access codes (with 4-8 digits), both permanently and for specific times and days of the week. Thus, for example, access to a holiday home can be optimally and securely controlled during changing holiday periods. And, in another example, cleaning staff can be granted access during an agreed time.

ABSOLUTELY SECURE

The Keypad benefits from the VDE-certified protocol, IT and data security of the Homematic IP system. This means that the internal Homematic IP door lock actuator is controlled from the outside via the keypad using a secure wireless command.

The integrated tamper contact also prevents the keypad from being tampered with by third parties.

EASY TO INSTALL, WITHOUT ANY CABLES

The Homematic IP Keypad can be easily mounted on the outside wall next to the entrance door using the enclosed mounting material. No need to use any existing or additional wiring. This greatly enhances the system's security, because there are no cables outside that could be tampered with.

PERSONALISED USE OF NUMERICAL CODES

In addition to locking and unlocking the front door, the light or the garage door can also be controlled by entering a code. The hall light can be switched on when you enter your home, for instance, and switched off when you leave.

And you can use garage door groups to program your garage door to raise or lower when you enter a code and confirmation.

LOGISTICS DATA

Product reference	156424A0
EAN code	4047976564248
Short description	HmlIP-WKP
Packing unit	72
Packing dimensions	182 x 90 x 45 mm
Weight incl. packaging	252,2 g

PACKAGE CONTENTS

Homematic IP Keypad
 Mounting plate
 Mounting material (screws and plugs)
 2x 1.5 V LR03/micro/AAA batteries
 Operating manual

SECURE AND SIMPLE
ACCESS TO YOUR
SMART HOME

Wiegand interface

HmiP-FWI

The Wiegand interface enables a Wiegand-enabled device, such as a code lock, fingerprint sensor or card/transponder reader, to be integrated into the Homematic IP smart home system. This creates numerous possibilities for controlling Wiegand-compatible devices via the free Homematic IP app and combining them with other Homematic IP devices.



homematic 
Smart living. Simply exciting.

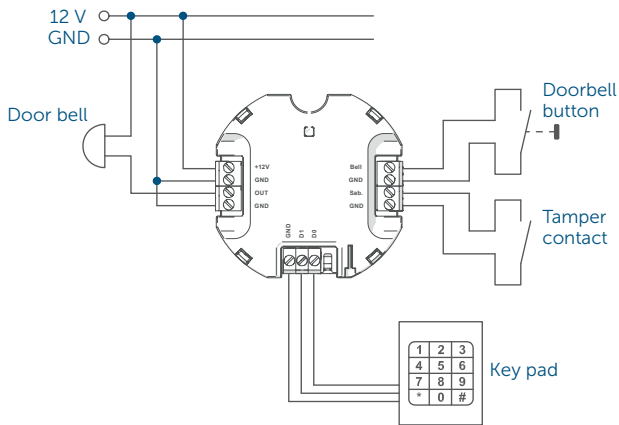

SMART INTERFACE

The Homematic IP Wiegand interface enables many Wiegand-enabled devices, such as a code lock, fingerprint sensor or card/transponder reader, to be integrated into the Homematic IP system.

Using the Homematic IP app, the Wiegand interface can be set up according to individual requirements and Wiegand-enabled devices can be integrated into a smart system. This makes access to a smart home not only secure but also smart and simple.



TECHNICAL SPECIFICATIONS

Supply voltage	5–12 VDC
Power consumption in standby	60 mW
Open-drain output:	
Max. switching voltage	20 V
Max. current	200 mA
Cable type and cross section	0.2 – 1.5 mm
Installation	Only in switch boxes (device boxes) in accordance with DIN 49073-1 or surface-mounting boxes in accordance with DIN 60670-1 (e.g. Abox 025 or Abox 040)
Degree of protection	IP20
Ambient temperature	-10 to +55 °C
Dimensions (W x H x D)	52 x 52 x 14 mm
Weight	20 g
Radio frequency band	868.0–868.6 MHz 869.4–869.65 MHz
Typical range in open space	210 m

INDIVIDUAL CONTROL

The Wiegand interface has eight virtual input channels that can be individually linked to the Wiegand codes. A Wiegand code can control one or more virtual input channels and thus trigger one or more actions (such as switching a switch actuator, opening a door via a door lock actuator or activating/deactivating alarm functions).

AN ARRAY OF POSSIBILITIES

In addition to the Wiegand inputs, the device has an input for connecting a doorbell button, an input for connecting a tamper contact, and a switching output with versatile applications, such as switching an LED or a bell.

SIMPLE INSTALLATION

The Wiegand interface's compact design means it fits into all common flush-mounting boxes. For ease of installation, flush-mounting boxes with a depth >50 mm are recommended.

The versatile wiring options offer the choice of use with the following Wiegand-compatible devices:

- ✓ Code lock
- ✓ Fingerprint sensor
- ✓ Card/transponder reader
- ✓ Doorbell
- ✓ Tamper contact

Operation requires connection to one of the following solutions:

- Homematic IP access point with free smartphone app and free cloud service
- Third-party partner solutions

LOGISTICS DATA

Product reference	155182A0
EAN code	4047976551828
Short description	HmlIP-FWI
Packing unit	144
Packing dimensions	122 x 93 x 36 mm
Weight incl. packaging	103.7 g

PACKAGE CONTENTS

Homematic IP Wiegand interface
Operating manual

OPENS THE DOOR
AT THE TOUCH OF A
BUTTON

Key Ring Remote Control – access control

HmIP-KRCK

The key ring remote control in combination with the Homematic IP Door Lock Drive is the ideal solution for convenient and intelligent unlocking, locking and opening of doors. The remote control replaces a standard key and allows you to enter your smart home with just one button press.

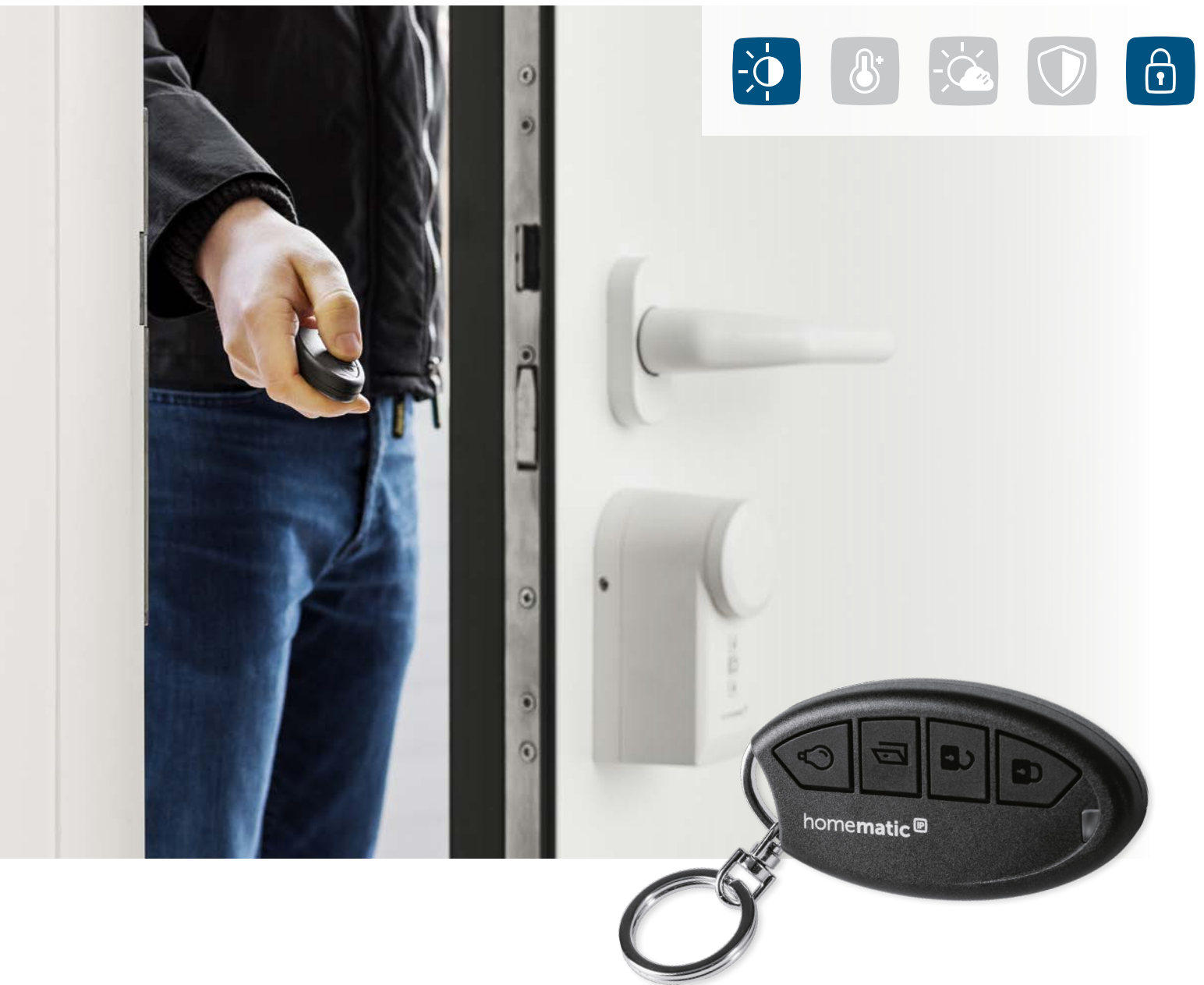

homematic ^{IP}
Smart Living, Simply Exciting.



IDEAL IN COMBINATION WITH THE HOMEMATIC IP DOOR LOCK DRIVE

The compact key ring remote control controls the Homematic IP Door Lock Drive, enabling entrance doors to be unlocked, locked and opened. The additional light button can be used, for example, to switch lighting in the entrance area on and off.



TECHNICAL SPECIFICATIONS

Supply voltage	1x 1.5 V LR03/micro/AAA
Battery life	2 years (typ.)
Degree of protection	IP20
Ambient temperature	-10 to +55 °C
Dimensions (W x H x D)	38 x 75 x 14 mm
Weight	38 g (incl. batteries)
Radio frequency band	868.0-868.6 MHz / 869.4-869.65 MHz
Typical open area RF range	200 m

SMART ALTERNATIVE TO THE HOUSE KEY

The remote control makes the need for a key to open the door unnecessary, and controlling the entrance door is as easy as child's play with just one button press. Thanks to configurable access authorisations, for each remote control an individual profile can be assigned. For example, cleaning staff can only enter the house at certain times.

CONVENIENT REMOTE CONTROL FOR THE KEY RING

With its compact design, the small remote control fits into every trouser pocket – or on your key ring. Thus, it is ideal for operation at home, in outdoor areas or in your car when coming home. If the remote control should ever get lost, it can simply be deactivated via the app.

POWERFUL AND ROBUST

The wide radio range of up to 200 metres enables the front door to be opened even on the way to the door. The housing made of halogen-free, glass-fibre reinforced plastic makes the remote control durable and it can withstand any situation thanks to its high temperature range. Each button press is confirmed directly via the integrated multicolour LED.

Operation requires connection to one of the following solutions:

- Homematic IP Access Point with free smartphone app and free cloud service
- Third-party solutions of partners

LOGISTICAL DATA

Product reference	142561A0
EAN code	4047976425617
Short description	HmlP-KRCK
Packing unit	144
Packing dimensions	122 x 93 x 36 mm
Weight incl. packaging	120.6 g

PACKAGE CONTENTS

Homematic IP Key Ring Remote Control – access control
 Key ring
 1.5 V LR03/micro/AAA battery
 User manual

SMART GARAGE DOOR
CONTROL AT THE PUSH
OF A BUTTON

Module for Hörmann drives

HmIP-MOD-HO

The module for Hörmann drives offers integration of garage door or entrance gate control into the Homematic IP smart home: door drives can be conveniently controlled via smartphone app and via a Homematic IP Remote Control.



homematic ^{IP}
Smart Living, Simply Exciting.



Easy click-in installation without any tools

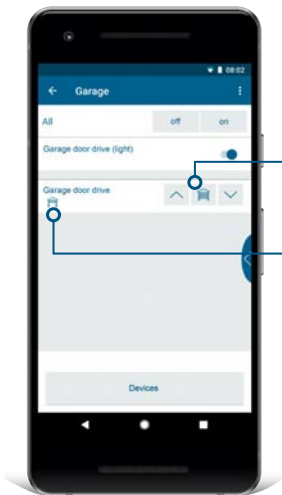

Comfortable garage door control:
Opening, closing and ventilation position

Status display:
Open, closed, moving

SMART CONTROL OF GARAGE AND ENTRANCE GATES

In combination with the module, garage and entrance doors can be comfortably controlled via the Homematic IP app. Control is also possible via various Homematic IP remote controls and push-buttons. Time profiles in the app offer automatic opening and closing*, e.g. of entrance doors.

FLEXIBLE USE FOR A LARGE NUMBER OF HÖRMANN MODULES

Compatible with the following drives:

- ✓ SupraMatic series 3 E/P from Index Ci
- ✓ SupraMatic HT3
- ✓ RotaMatic/P/PL series 1 (from 09/2010) and series 2
- ✓ LineaMatic/P/H series 1 (from 10/2009) and series 2
- ✓ VersaMatic/P
- ✓ WA300 S4
- ✓ WA300 R S4

Hörmann HAP1 HCP Adapter to HmIP-MOD-HO additionally required, ordering no. 170046:

- ✓ Liftronic 700-2/800-2
- ✓ RollMatic 2
- ✓ SupraMatic/ProMatic series 4



MONITORING OF GARAGE DOORS

The status of the garage door (moving, open, closed, partial opening e.g. for ventilation) can be checked at any time via the Homematic IP app.

EASY INSTALLATION WITHOUT ANY TOOLS

Custom-fit design for concealed installation into compatible Hörmann drives. The connecting cable with plug connectors allows for quick connection to the drive without tools. Additional power supply is not required, as power is supplied by the Hörmann drive.

* An additional light barrier is required if the door is not in sight during operation.

LOGISTICAL DATA

Product reference	153986A0
EAN code	4047976539864
Short description	HmIP-MOD-HO
Packing unit	90
Packing dimensions	122 x 112 x 48 mm
Weight incl. packaging	116.2 g

PACKAGE CONTENTS

Homematic IP Module for Hörmann drives
Connecting cable
User manual and QR code sticker

To enable operation, the device has to be connected with one of the following solutions:

- Homematic IP Access Point with free smartphone app and free cloud service
- Third-party solutions of partners

TECHNICAL SPECIFICATIONS

Supply voltage	supplied by Hörmann drive
Ambient temperature	-20 to +60 °C
Dimensions (W x H x D)	48 x 52 x 16 mm
Weight	26 g
Radio frequency band	868.0-868.6 MHz 869.4-869.65 MHz
Typ. open area RF range	250 m

URNS ANY
CKET INTO A
SMART PLUG

Pluggable Switch

HmlIP-PS-2

Remotely control connected devices any time and anywhere. The Homematic IP Pluggable Switch offers control via wireless push-buttons, voice control or Homematic IP app. For example, individual time profiles can be used to control the reading light, TV or ambient light on or off.

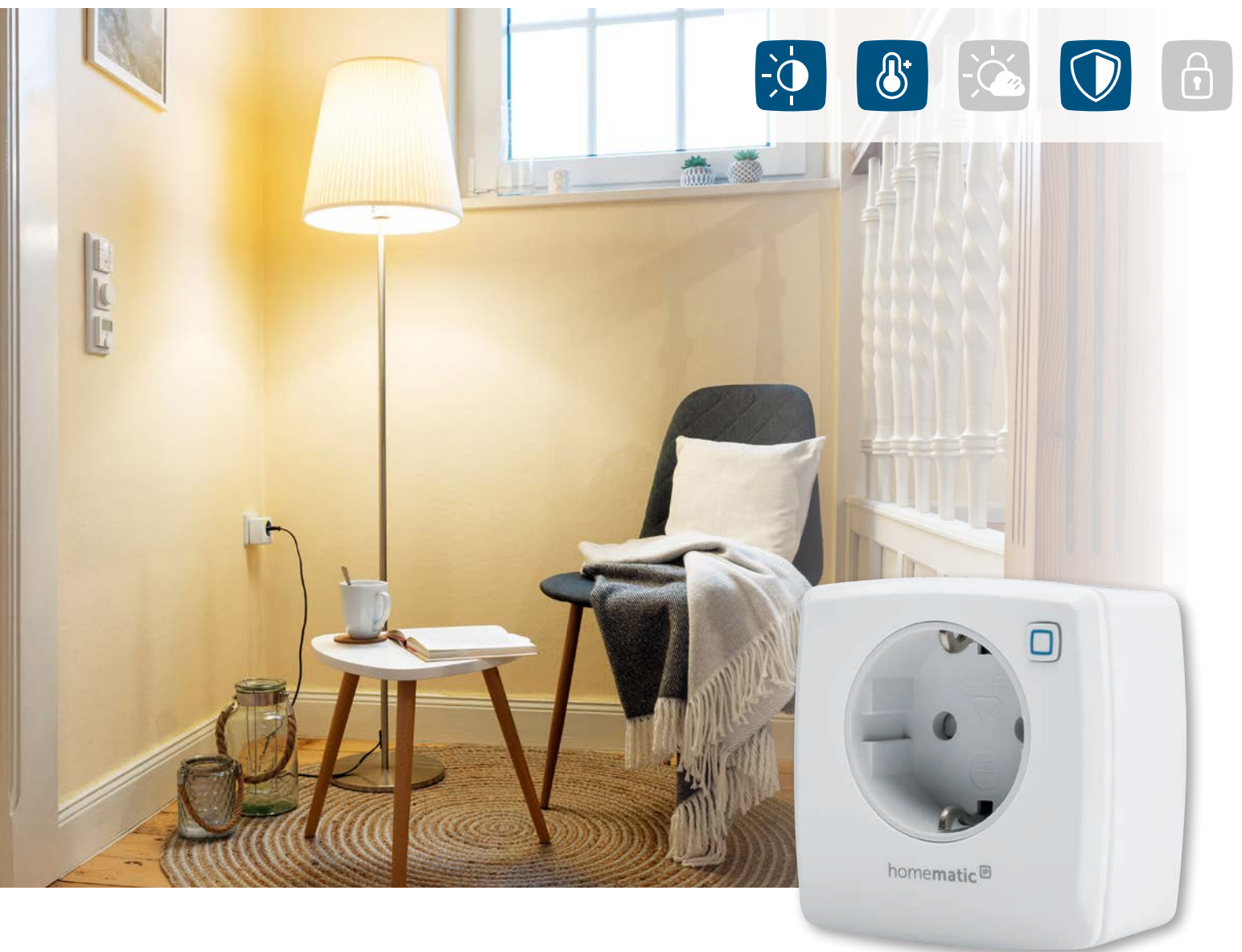

homematic ^{IP}
Smart Living, Simply Exciting.

SMART PLUG FOR YOUR HOME

Switches almost all conventional electrical devices – via Homematic IP Push-buttons and Remote Controls, voice command, directly on the device or via smartphone, whether at home or on the move. The device offers individual control of floor lamps, radios, humidifiers, ventilators or even devices with higher loads like electrical radiators, for example.

This allows the devices to be adapted to your daily routine. For example, they can be switched on and off automatically at any desired time or depending on sunrise or sunset.

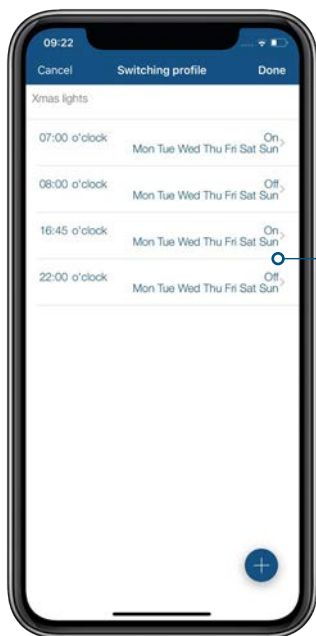

The app can be used to set individual time profiles.

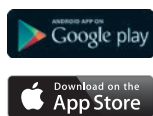

NO WASTE OF ENERGY

With the pluggable switch, no energy is wasted of devices in stand-by mode. The device only switches electrical devices if they are needed. For example, the power supply of the TV is switched off at night and only switched on again the next morning.

If you have forgotten a device, it can be switched off again remotely via the app. Another benefit: the low standby consumption of the pluggable switch offers energy-saving operation of the device itself.

GET STARTED

Simply plug-in the device into a free socket – that's it! Thanks to the compact design, the device does not block the surrounding sockets.

"ALEXA, TURN OFF THE TV"

The pluggable switch can even be operated conveniently from the sofa – simply by voice command using Amazon Alexa or Google Assistant.

RANGE EXTENSION

Can be used to extend the wireless range of the radio signal. For further information, please refer to the Homematic IP user guide.

To enable operation, the device has to be connected with one of the following solutions:

- Homematic IP Access Point with free smartphone app and free cloud service
- Third-party solutions of partners

TECHNICAL SPECIFICATIONS

Supply voltage	230 V/50 Hz
Current consumption	13 A max.
Standby power consumption	< 0.3 W
Max. switching capacity	3 kW
Load type	ohmic load
Degree of protection	IP20
Ambient temperature	-10 to +35 °C
Dimensions (W x H x D)	70 x 70 x 39 mm (not incl. mains plug)
Weight	154 g
Radio frequency band	868.0-868.6 MHz/ 869.4-869.65 MHz
Typical open area RF range	400 m

LOGISTICAL DATA

Product reference	157338A0
EAN code	4047976573387
Short description	HmIP-PS-2
Packing unit	45
Packing dimensions	122 x 112 x 97 mm
Weight incl. packaging	290.0 g

PACKAGE CONTENTS

Homematic IP Pluggable Switch
User manual

SMART CONTROL
AND ENERGY
MONITORING

Pluggable Switch and Meter

HmIP-PSM-2

Remotely control connected devices any time and anywhere. The Homematic IP Pluggable Switch and Meter offers control via wireless push-buttons, voice control or Homematic IP app. And at the same time, the power consumption of connected devices is measured.



homematic ^{IP}
Smart Living, Simply Exciting.

SMART PLUG FOR YOUR HOME

Switches almost all conventional electrical devices – via Homematic IP Push-buttons and Remote Controls, voice command, directly on the device or via smartphone, whether at home or on the move. The device offers individual control of floor lamps, radios, humidifier, ventilators or even devices with higher loads like electrical radiators, for example.

This allows the devices to be adapted to your daily routine. For example, they can be switched on and off automatically at any desired time or depending on sunrise or sunset.

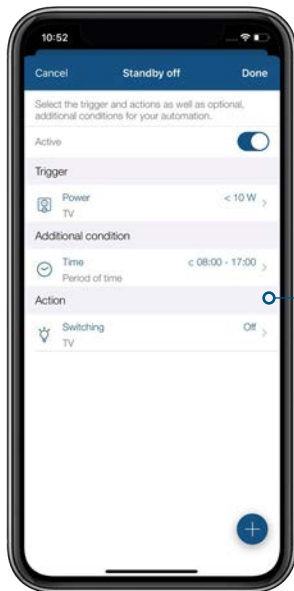

TV off in standby mode?
No problem!

The app can be used to set individually programmed automation rules.

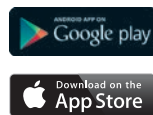

TECHNICAL SPECIFICATIONS

Supply voltage	230 V/50 Hz
Current consumption	13 A max.
Standby power consumption	< 0.3 W
Max. switching capacity	3 kW
Measuring accuracy (power)	measuring range: 0 to 3 kW resolution: 0.01 W accuracy: 1% ± 0.03 W*
Load type	ohmic load, $\cos\phi \geq 0.95$
Degree of protection	IP20
Ambient temperature	-10 to +35 °C
Dimensions (W x H x D)	70 x 70 x 39 mm (not incl. mains plug)
Weight	154 g
Radio frequency band	868.0-868.6 MHz 869.4-869.65 MHz
Typical open area RF range	400 m

KEEP YOUR POWER CONSUMPTION UNDER CONTROL

The metering function makes sure, that no energy is wasted. Consumption values and costs of connected electronic devices can be monitored using the app. This helps to identify power guzzlers in the household and thus only switches devices on when they are needed.

Thanks to the high measuring accuracy, the pluggable switch and meter can also be integrated into individual programming, so that devices can be switched on or off automatically at high or low energy consumption.

Another benefit: the low standby consumption of the pluggable switch and meter offers energy-saving operation of the device itself.

GET EASILY STARTED

Simply plug-in the device into a free standard socket – that's it! The pluggable switch and meter can be installed into any socket in your smart home. Thanks to the compact design, the device does not block the surrounding sockets.

"ALEXA, TURN OFF THE TV"

The pluggable switch and meter can even be operated conveniently from the sofa – simply by voice command using Amazon Alexa or Google Assistant.

RANGE EXTENSION

Can be used to extend the wireless range of the radio signal. For further information, please refer to the Homematic IP user guide.

To enable operation, the device has to be connected with one of the following solutions:

- Homematic IP Access Point with free smartphone app and free cloud service
- Third-party solutions of partners

LOGISTICAL DATA

Product reference	157337A0
EAN code	4047976573370
Short description	HmIP-PSM-2
Packing unit	45
Packing dimensions	122 x 112 x 97 mm
Weight incl. packaging	289.6 g

PACKAGE CONTENTS

Homematic IP Pluggable Switch and Meter
User manual

SMART CONTROL
AND ENERGY
MONITORING

Pluggable Switch and Meter (CH)

HmIP-PSM-CH

Remotely control connected devices any time and anywhere. The Homematic IP Pluggable Switch and Meter offers control via wireless push-buttons, voice control or Homematic IP app. And at the same time, the power consumption of connected devices is measured.

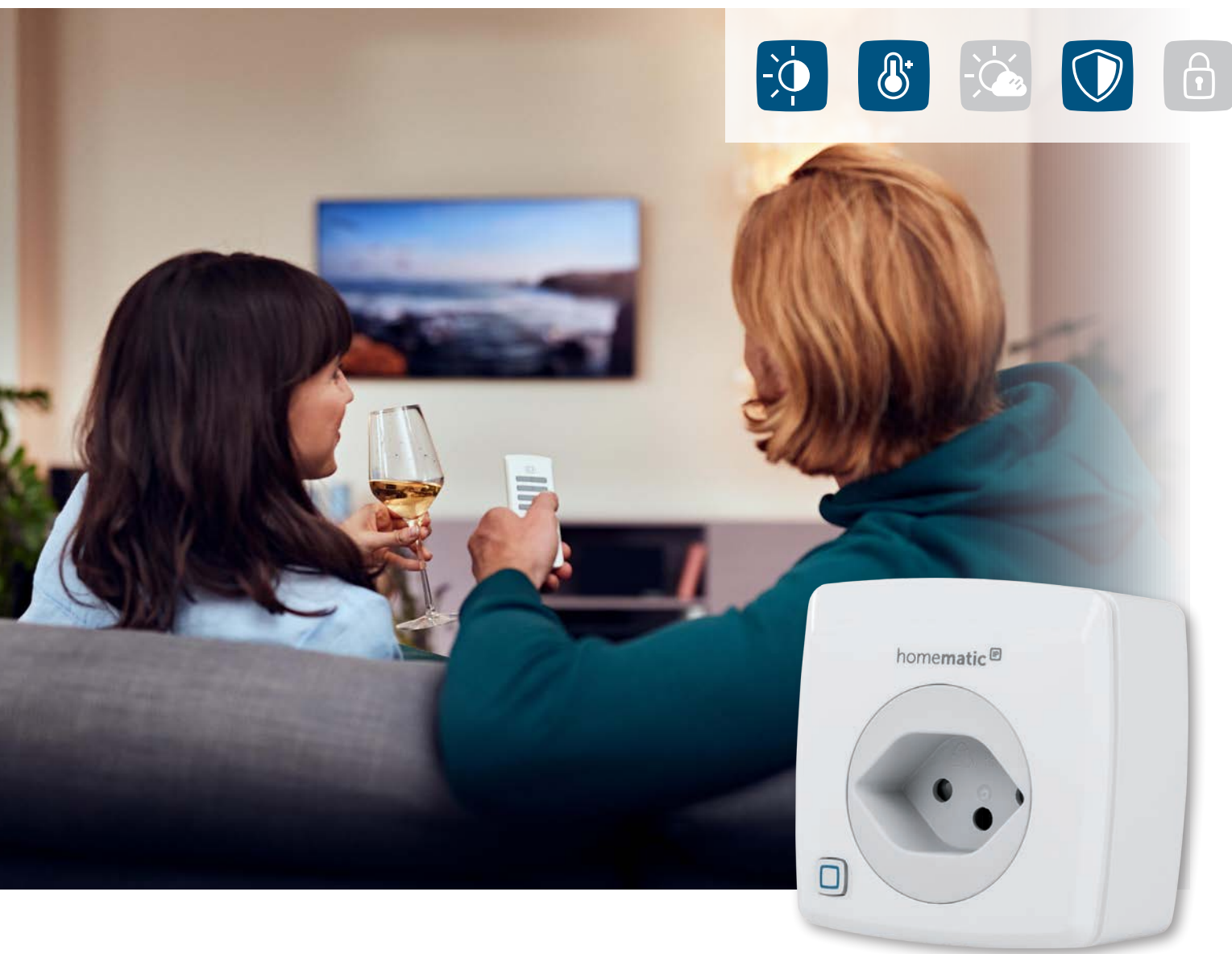

homematic ^{IP}
Smart Living, Simply Exciting.

SMART PLUG FOR YOUR HOME

Switches almost all conventional electrical devices – via Homematic IP Push-buttons and Remote Controls, voice command, directly on the device or via smartphone, whether at home or on the move. The device offers individual control of floor lamps, radios, humidifier, ventilators or even devices with higher loads like electrical radiators, for example.

This allows the devices to be adapted to your daily routine. For example, they can be switched on and off automatically at any desired time or depending on sunrise or sunset.

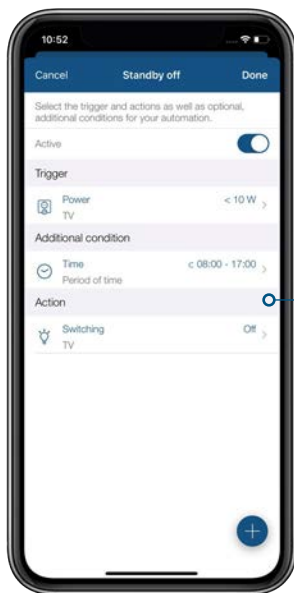

TV off in standby mode?
No problem!

The app can be used to set individually programmed automation rules.

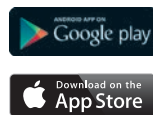

TECHNICAL SPECIFICATIONS

Supply voltage	230 V/50 Hz
Current consumption	10 A max.
Standby power consumption	< 0.3 W
Max. switching capacity	2300 W
Measuring accuracy (power)	measuring range: 0 to 2300 W resolution: 0.01 W accuracy: 1% ± 0.03 W*
Load type	ohmic load, $\cos\phi \geq 0.95$
Degree of protection	IP20
Ambient temperature	-10 to +35 °C
Dimensions (W x H x D)	70 x 70 x 39 mm (not incl. mains plug)
Weight	142 g
Radio frequency band	868.0-868.6 MHz 869.4-869.65 MHz
Typical open area RF range	400 m

KEEP YOUR POWER CONSUMPTION UNDER CONTROL

The metering function makes sure, that no energy is wasted. Consumption values and costs of connected electronic devices can be monitored using the app. This helps to identify power guzzlers in the household and thus only switches devices on when they are needed.

Thanks to the high measuring accuracy, the pluggable switch and meter can also be integrated into individual programming, so that devices can be switched on or off automatically at high or low energy consumption.

Another benefit: the low standby consumption of the pluggable switch and meter offers energy-saving operation of the device itself.

GET EASILY STARTED

Simply plug-in the device into a free standard socket – that's it! The pluggable switch and meter can be installed into any socket in your smart home. Thanks to the compact design, the device does not block the surrounding sockets.

"ALEXA, TURN OFF THE TV"

The pluggable switch and meter can even be operated conveniently from the sofa – simply by voice command using Amazon Alexa or Google Assistant.

RANGE EXTENSION

Can be used to extend the wireless range of the radio signal. For further information, please refer to the Homematic IP user guide.

To enable operation, the device has to be connected with one of the following solutions:

- Homematic IP Access Point with free smartphone app and free cloud service
- Third-party solutions of partners

LOGISTICAL DATA

Product reference	150009A0
EAN code	4047976500093
Short description	HmIP-PSM-CH
Packing unit	45
Packing dimensions	122 x 112 x 97 mm
Weight incl. packaging	270.0 g

PACKAGE CONTENTS

Homematic IP Pluggable Switch and Meter (CH)
User manual

SMART CONTROL
AND ENERGY
MONITORING

Pluggable Switch and Meter (IT)

HmIP-PSM-IT

Remotely control connected devices any time and anywhere. The Homematic IP Pluggable Switch and Meter offers control via wireless push-buttons, voice control or Homematic IP app. And at the same time, the power consumption of connected devices is measured.



homematic ^{IP}
Smart Living, Simply Exciting.

SMART PLUG FOR YOUR HOME

Switches almost all conventional electrical devices – via Homematic IP Push-buttons and Remote Controls, voice command, directly on the device or via smartphone, whether at home or on the move. The device offers individual control of floor lamps, radios, humidifier, ventilators or even devices with higher loads like electrical radiators, for example.

This allows the devices to be adapted to your daily routine. For example, they can be switched on and off automatically at any desired time or depending on sunrise or sunset.

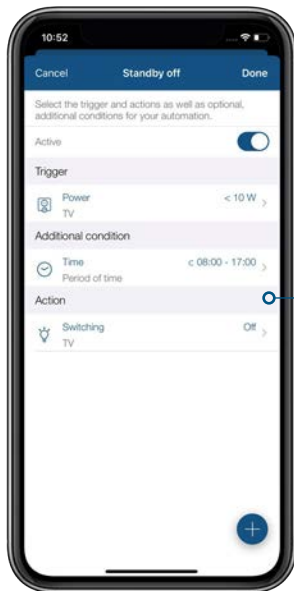

TV off in standby mode?
No problem!

The app can be used to set individually programmed automation rules.

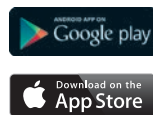

KEEP YOUR POWER CONSUMPTION UNDER CONTROL

The metering function makes sure, that no energy is wasted. Consumption values and costs of connected electronic devices can be monitored using the app. This helps to identify power guzzlers in the household and thus only switches devices on when they are needed.

Thanks to the high measuring accuracy, the pluggable switch and meter can also be integrated into individual programming, so that devices can be switched on or off automatically at high or low energy consumption.

Another benefit: the low standby consumption of the pluggable switch and meter offers energy-saving operation of the device itself.

GET EASILY STARTED

Simply plug-in the device into a free standard socket – that's it! The pluggable switch and meter can be installed into any socket in your smart home. Thanks to the compact design, the device does not block the surrounding sockets.

"ALEXA, TURN OFF THE TV"

The pluggable switch and meter can even be operated conveniently from the sofa – simply by voice command using Amazon Alexa or Google Assistant.

RANGE EXTENSION

Can be used to extend the wireless range of the radio signal. For further information, please refer to the Homematic IP user guide.

TECHNICAL SPECIFICATIONS

Supply voltage	230 V/50 Hz
Current consumption	16 A max.
Standby power consumption	< 0.3 W
Max. switching capacity	3680 W
Measuring accuracy (power)	measuring range: 0 to 3680 W resolution: 0.01 W accuracy: 1% ± 0.03 W*
Load type	ohmic load, $\cos\phi \geq 0.95$
Degree of protection	IP20
Ambient temperature	-10 to +35 °C
Dimensions (W x H x D)	70 x 70 x 39 mm (not incl. mains plug)
Weight	156 g
Radio frequency band	868.0-868.6 MHz 869.4-869.65 MHz
Typical open area RF range	400 m

To enable operation, the device has to be connected with one of the following solutions:

- Homematic IP Access Point with free smartphone app and free cloud service
- Third-party solutions of partners

LOGISTICAL DATA

Product reference	150008A0
EAN code	4047976500086
Short description	HmIP-PSM-IT
Packing unit	45
Packing dimensions	122 x 112 x 97 mm
Weight incl. packaging	280.0 g

PACKAGE CONTENTS

Homematic IP Pluggable Switch and Meter (Pin-Earth)
User manual

SMART CONTROL
AND ENERGY
MONITORING

Pluggable Switch and Meter (Pin-Earth)

HmIP-PSM-PE

Remotely control connected devices any time and anywhere. The Homematic IP Pluggable Switch and Meter offers control via wireless push-buttons, voice control or Homematic IP app. And at the same time, the power consumption of connected devices is measured.

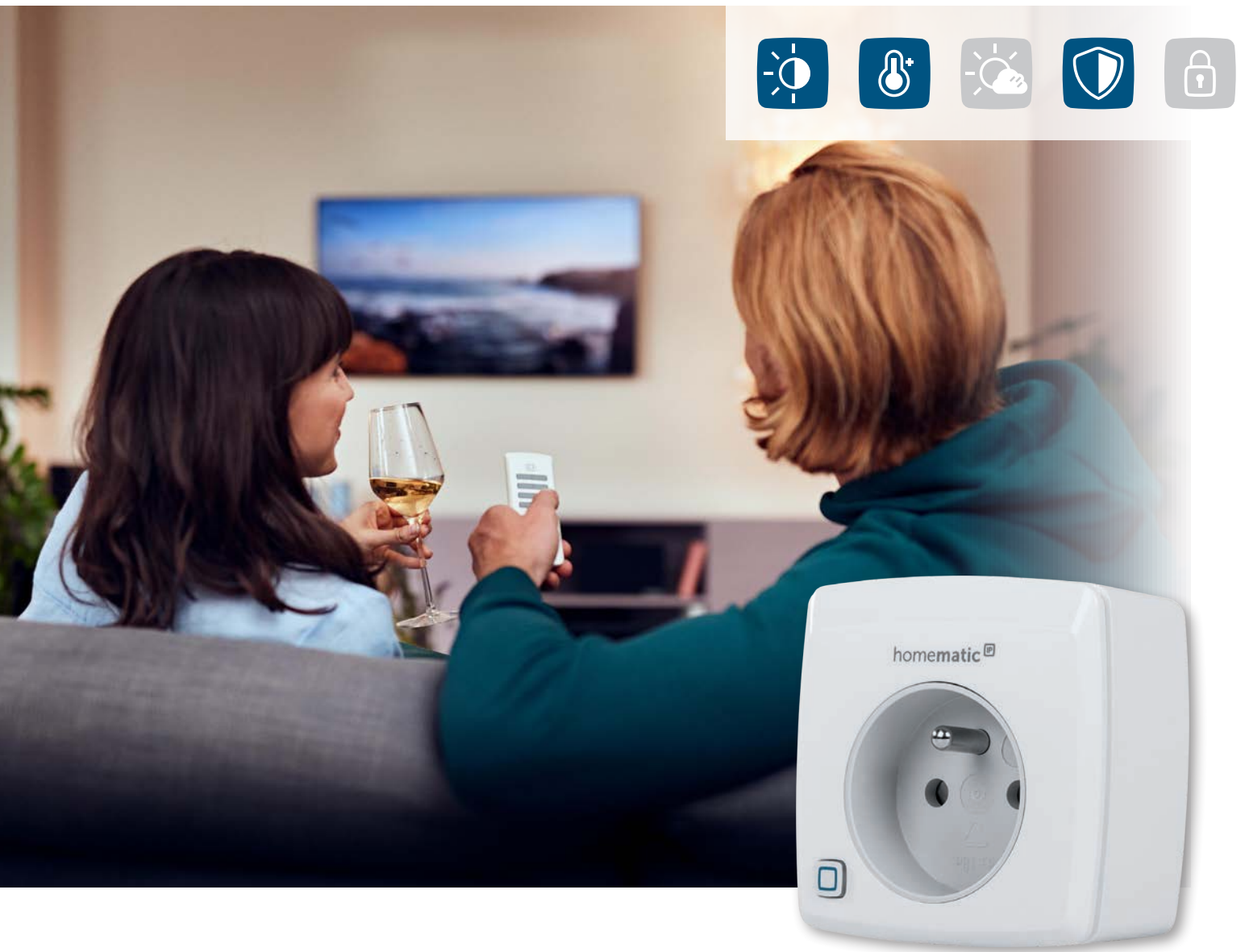

homematic ^{IP}
Smart Living, Simply Exciting.

SMART PLUG FOR YOUR HOME

Switches almost all conventional electrical devices – via Homematic IP Push-buttons and Remote Controls, voice command, directly on the device or via smartphone, whether at home or on the move. The device offers individual control of floor lamps, radios, humidifier, ventilators or even devices with higher loads like electrical radiators, for example.

This allows the devices to be adapted to your daily routine. For example, they can be switched on and off automatically at any desired time or depending on sunrise or sunset.

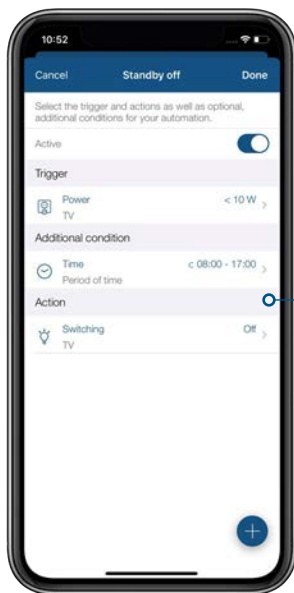

TV off in standby mode?
No problem!

The app can be used to set individually programmed automation rules.

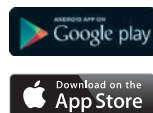

KEEP YOUR POWER CONSUMPTION UNDER CONTROL

The metering function makes sure, that no energy is wasted. Consumption values and costs of connected electronic devices can be monitored using the app. This helps to identify power guzzlers in the household and thus only switches devices on when they are needed.

Thanks to the high measuring accuracy, the pluggable switch and meter can also be integrated into individual programming, so that devices can be switched on or off automatically at high or low energy consumption.

Another benefit: the low standby consumption of the pluggable switch and meter offers energy-saving operation of the device itself.

GET EASILY STARTED

Simply plug-in the device into a free standard socket – that's it! The pluggable switch and meter can be installed into any socket in your smart home. Thanks to the compact design, the device does not block the surrounding sockets.

"ALEXA, TURN OFF THE TV"

The pluggable switch and meter can even be operated conveniently from the sofa – simply by voice command using Amazon Alexa or Google Assistant.

RANGE EXTENSION

Can be used to extend the wireless range of the radio signal. For further information, please refer to the Homematic IP user guide.

To enable operation, the device has to be connected with one of the following solutions:

- Homematic IP Access Point with free smartphone app and free cloud service
- Third-party solutions of partners

TECHNICAL SPECIFICATIONS

Supply voltage	230 V/50 Hz
Current consumption	16 A max.
Standby power consumption	< 0.3 W
Max. switching capacity	3680 W
Measuring accuracy (power)	measuring range: 0 to 3680 W resolution: 0.01 W accuracy: 1% ± 0.03 W*
Load type	ohmic load, $\cos\phi \geq 0.95$
Degree of protection	IP20
Ambient temperature	-10 to +35 °C
Dimensions (W x H x D)	70 x 70 x 39 mm (not incl. mains plug)
Weight	152 g
Radio frequency band	868.0-868.6 MHz 869.4-869.65 MHz
Typical open area RF range	400 m

LOGISTICAL DATA

Product reference	150006A0
EAN code	4047976500062
Short description	HmIP-PSM-PE
Packing unit	45
Packing dimensions	122 x 112 x 97 mm
Weight incl. packaging	280.0 g

PACKAGE CONTENTS

Homematic IP Pluggable Switch and Meter (Pin-Earth)
User manual

SMART CONTROL
AND ENERGY
MONITORING

Pluggable Switch and Meter (UK)

HmIP-PSM-UK

Remotely control connected devices any time and anywhere. The Homematic IP Pluggable Switch and Meter offers control via wireless push-buttons, voice control or Homematic IP app. And at the same time, the power consumption of connected devices is measured.



homematic ^{IP}
Smart Living, Simply Exciting.

SMART PLUG FOR YOUR HOME

Switches almost all conventional electrical devices – via Homematic IP Push-buttons and Remote Controls, voice command, directly on the device or via smartphone, whether at home or on the move. The device offers individual control of floor lamps, radios, humidifier, ventilators or even devices with higher loads like electrical radiators, for example.

This allows the devices to be adapted to your daily routine. For example, they can be switched on and off automatically at any desired time or depending on sunrise or sunset.

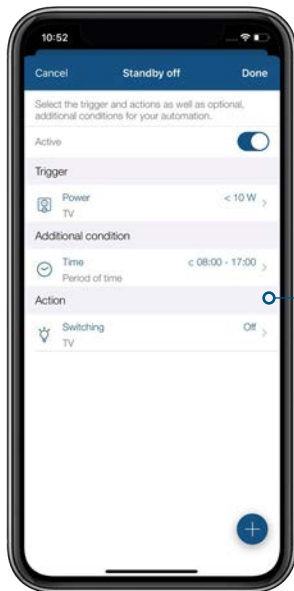

TV off in standby mode?
No problem!

The app can be used to set individually programmed automation rules.

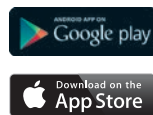

KEEP YOUR POWER CONSUMPTION UNDER CONTROL

The metering function makes sure, that no energy is wasted. Consumption values and costs of connected electronic devices can be monitored using the app. This helps to identify power guzzlers in the household and thus only switches devices on when they are needed.

Thanks to the high measuring accuracy, the pluggable switch and meter can also be integrated into individual programming, so that devices can be switched on or off automatically at high or low energy consumption.

Another benefit: the low standby consumption of the pluggable switch and meter offers energy-saving operation of the device itself.

GET EASILY STARTED

Simply plug-in the device into a free standard socket – that's it! The pluggable switch and meter can be installed into any socket in your smart home. Thanks to the compact design, the device does not block the surrounding sockets.

"ALEXA, TURN OFF THE TV"

The pluggable switch and meter can even be operated conveniently from the sofa – simply by voice command using Amazon Alexa or Google Assistant.

RANGE EXTENSION

Can be used to extend the wireless range of the radio signal. For further information, please refer to the Homematic IP user guide.

To enable operation, the device has to be connected with one of the following solutions:

- Homematic IP Access Point with free smartphone app and free cloud service
- Third-party solutions of partners

TECHNICAL SPECIFICATIONS

Supply voltage	230 V/50 Hz
Current consumption	13 A max.
Standby power consumption	< 0.3 W
Max. switching capacity	2990 W
Measuring accuracy (power)	measuring range: 0 to 2990 W resolution: 0.01 W accuracy: 1% ± 0.03 W*
Load type	ohmic load, $\cos\phi \geq 0.95$
Degree of protection	IP20
Ambient temperature	-10 to +35 °C
Dimensions (W x H x D)	70 x 70 x 39 mm (not incl. mains plug)
Weight	157 g
Radio frequency band	868.0-868.6 MHz 869.4-869.65 MHz
Typical open area RF range	400 m

LOGISTICAL DATA

Product reference	150007A0
EAN code	4047976500079
Short description	HmIP-PSM-UK
Packing unit	45
Packing dimensions	122 x 112 x 97 mm
Weight incl. packaging	277.0 g

PACKAGE CONTENTS

Homematic IP Pluggable Switch and Meter (UK)
User manual

DIMMED LIGHTS –
EASY AND SMART

Pluggable Dimmer – trailing edge

HmIP-PDT

The compact pluggable dimmer allows connected lamps to be dimmed and switched on or off. Suitable illuminants can thus be controlled at any time via radio using a wall-mounted push-button, automatically via time profile using the free smartphone app or simply by voice command.

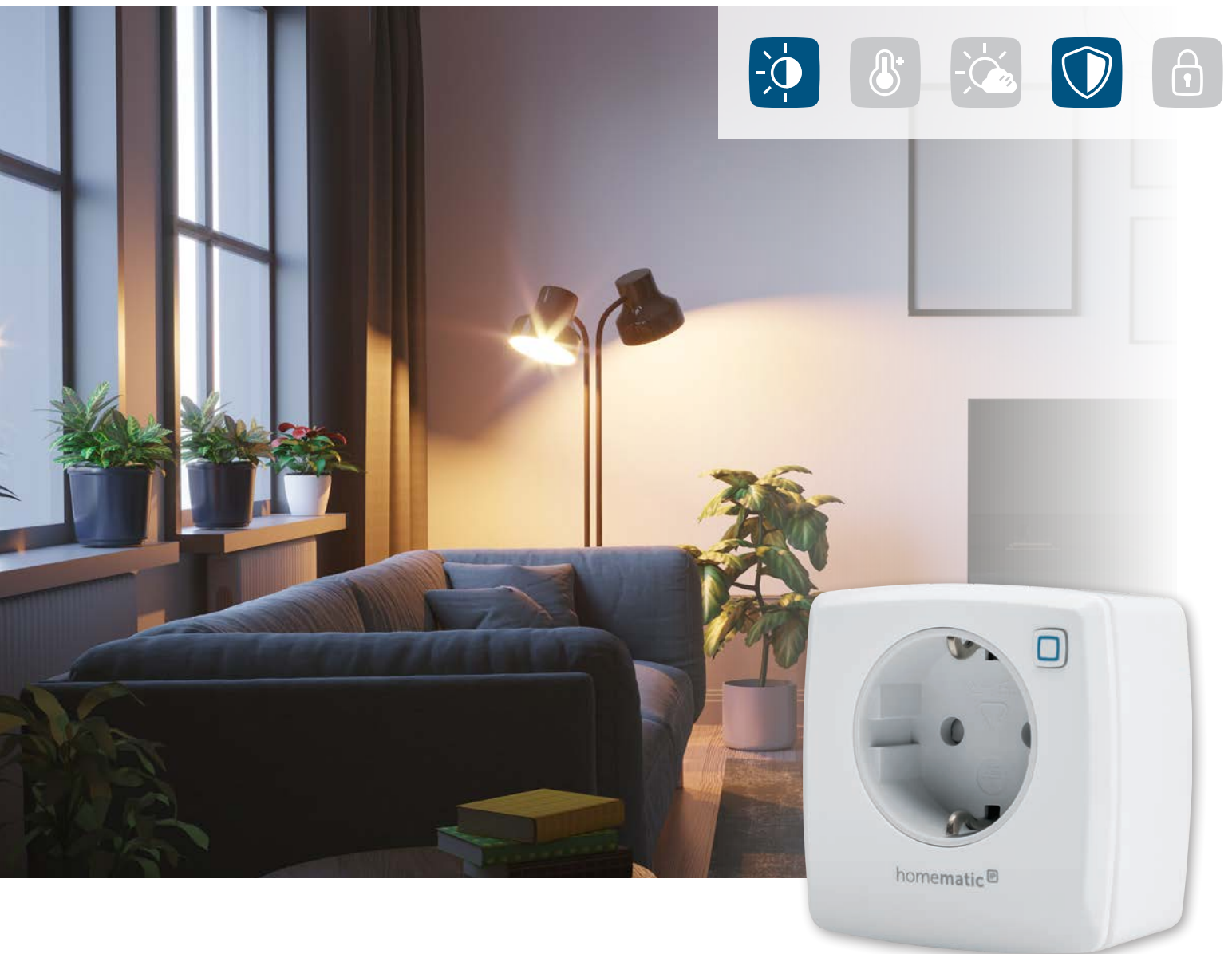

homematic ^{IP}
Smart Living, Simply Exciting.

SMART CONTROL AND DIMMING OF LIGHTS

Almost infinitely variable dimming and switching of the connected lights provides for the ideal lighting atmosphere in the smart home: The dimming value can be set individually via the Homematic IP app.

In addition to flexible control via smartphone, remote control, motion detector or voice command, the pluggable dimmer can also be operated manually directly on the device.

The lighting can also be switched on and off or dimmed automatically at the time you like using adjustable time profiles.



The dimming value can be defined individually via the app



TECHNICAL SPECIFICATIONS

Supply voltage	230 V/50 Hz
Current consumption	0.35 A max.
Standby power consumption	0.4 W
Max. switching capacity	80 VA
Minimum load	3 VA
Load type	ohmic and capacitive lamp load
Dimming method	reverse phase control
Degree of protection	IP20
Ambient temperature	-10 to +55 °C
Dimensions (W x H x D)	70 x 70 x 39 mm (not incl. mains plug)
Weight	138 g
Radio frequency band	868.0-868.6 MHz 869.4-869.65 MHz
Typ. open area RF range	170 m

SILENT, ENERGY-SAVING AND FLEXIBLE OPERATION

Compared to some older dimmers, the modern electronics of the trailing-edge dimming actuator allows operation without any noise emission.

Another benefit: the low standby consumption of the device offers energy-saving operation.

In addition, the dimming actuator can be used for a variety of modern light sources (even for particularly small loads):

- ✓ Dimmable LEDs
- ✓ Dimmable energy-saving lamps
- ✓ Classic incandescent lamps
- ✓ HV halogen lamps
- ✓ NV halogen lamps with electronic transformer

SMART WAY TO WAKE UP

Start relaxed into the day: Dimmable lights can slowly be switched on automatically, at sunrise or any desired time.

"ALEXA, TURN OFF THE LIGHTS!"

The pluggable dimmer can even be operated conveniently from the sofa – simply by voice control using Amazon Alexa or Google Assistant.

GET STARTED

Simply plug-in the device into a free socket – that's it! Thanks to the compact design, the device does not block the surrounding sockets.

To enable operation, the device has to be connected with one of the following solutions:

- Homematic IP Access Point with free smartphone app and free cloud service
- Central Control Unit CCU3 with the local user interface WebUI
- Third-party solutions of partners

LOGISTICAL DATA

Product reference	150327A0
EAN code	4047976503278
Short description	HmIP-PDT
Packing unit	45
Packing dimensions	122 x 112 x 97 mm
Weight incl. packaging	260.4 g

PACKAGE CONTENTS

Homematic IP Pluggable Dimmer – trailing edge
User manual

DIMMED LIGHTS –
EASY AND SMART

Pluggable Dimmer – trailing edge (UK)

HmIP-PDT-UK

The compact pluggable dimmer allows connected lamps to be dimmed and switched on or off. Suitable illuminants can thus be controlled at any time via radio using a wall-mounted push-button, automatically via time profile using the free smartphone app or simply by voice command.



homematic 
Smart Living, Simply Exciting.

SMART CONTROL AND DIMMING OF LIGHTS

Almost infinitely variable dimming and switching of the connected lights provides for the ideal lighting atmosphere in the smart home: The dimming value can be set individually via the Homematic IP app.

In addition to flexible control via smartphone, remote control, motion detector or voice command, the pluggable dimmer can also be operated manually directly on the device.

The lighting can also be switched on and off or dimmed automatically at the time you like using adjustable time profiles.



The dimming value can be defined individually via the app



SILENT, ENERGY-SAVING AND FLEXIBLE OPERATION

Compared to some older dimmers, the modern electronics of the trailing-edge dimming actuator allows operation without any noise emission.

Another benefit: the low standby consumption of the device offers energy-saving operation.

In addition, the dimming actuator can be used for a variety of modern light sources (even for particularly small loads):

- ✓ Dimmable LEDs
- ✓ Dimmable energy-saving lamps
- ✓ Classic incandescent lamps
- ✓ HV halogen lamps
- ✓ NV halogen lamps with electronic transformer

SMART WAY TO WAKE UP

Start relaxed into the day: Dimmable lights can slowly be switched on automatically, at sunrise or any desired time.

"ALEXA, TURN OFF THE LIGHTS!"

The pluggable dimmer can even be operated conveniently from the sofa – simply by voice control using Amazon Alexa or Google Assistant.

GET STARTED

Simply plug-in the device into a free socket – that's it! Thanks to the compact design, the device does not block the surrounding sockets.

To enable operation, the device has to be connected with one of the following solutions:

- Homematic IP Access Point with free smartphone app and free cloud service
- Third-party solutions of partners

TECHNICAL SPECIFICATIONS

Supply voltage	230 V/50 Hz
Current consumption	0.35 A max.
Standby power consumption	0.4 W
Max. switching capacity	80 VA
Minimum load	3 VA
Load type	ohmic and capacitive lamp load
Dimming method	reverse phase control
Degree of protection	IP20
Ambient temperature	-10 to +35 °C
Dimensions (W x H x D)	70 x 70 x 39 mm (not incl. mains plug)
Weight	138 g
Radio frequency band	868.0-868.6 MHz 869.4-869.65 MHz
Typ. open area RF range	170 m

LOGISTICAL DATA

Product reference	151479A0
EAN code	4047976514793
Short description	HmIP-PDT-UK
Packing unit	45
Packing dimensions	122 x 112 x 97 mm
Weight incl. packaging	260.5 g

PACKAGE CONTENTS

Homematic IP Pluggable Dimmer – trailing edge (UK)
User manual

**DIMMED LIGHT –
SET UP SIMPLY AND
SMARTLY**

Pluggable Dimmer – trailing edge (CH)

HmIP-PDT-CH

As a compact adapter, the pluggable dimmer enables connected lamps to be dimmed as well as switched on and off. In this way, suitable lamps can be controlled at any time by radio via a wall switch, fully automatically by means of a time profile via the free smartphone app or really easily by means of voice control.

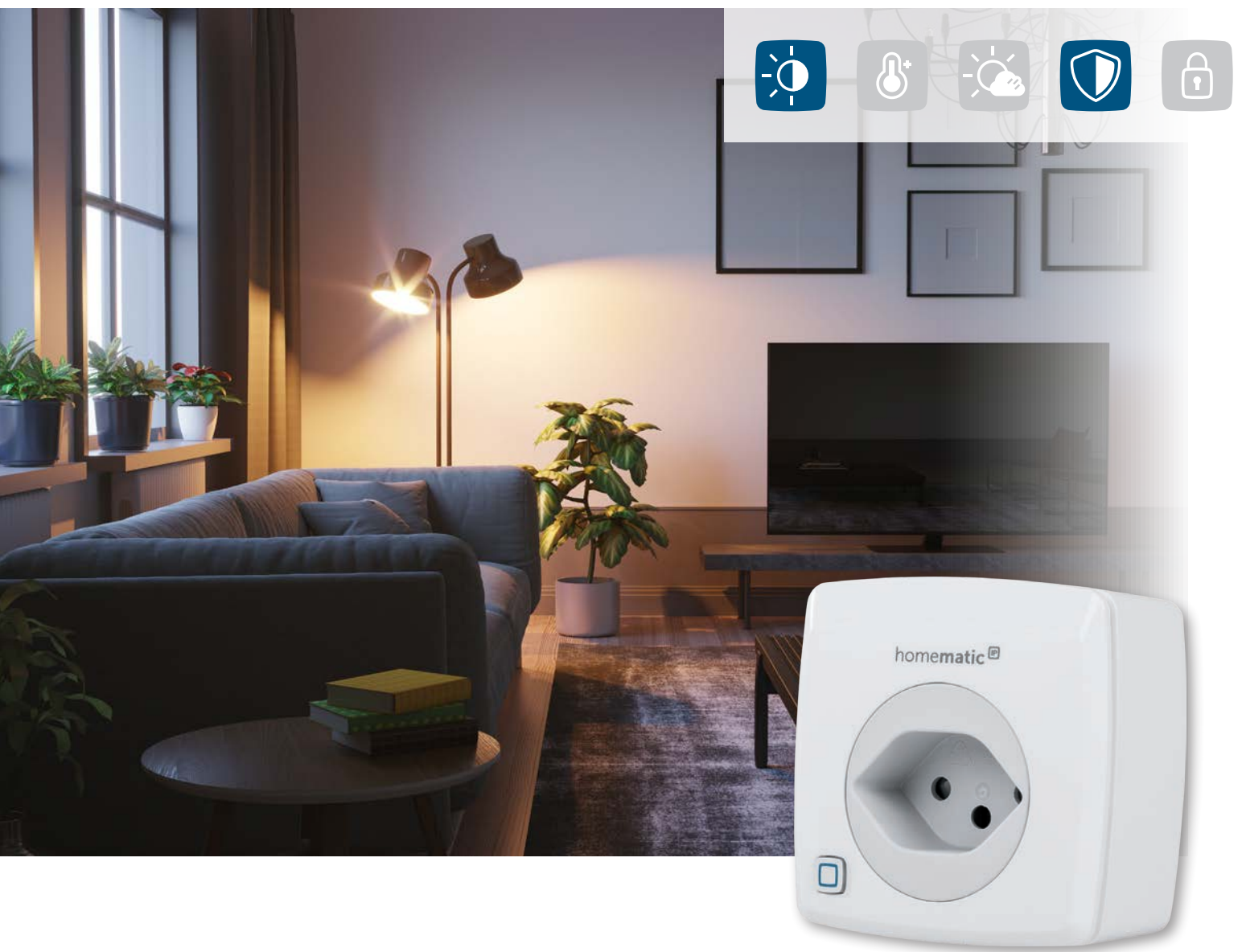

homematic 
Smart living, simply comfortable

INTELLIGENT LIGHT SWITCHING AND DIMMING

Almost infinitely variable dimming and switching of the connected lights to create the ideal lighting mood in your smart home. Using the Homematic IP app, you can individually select the desired dimming level.

Alternatively to flexible control by smartphone, remote control, motion sensor or voice control, the pluggable dimmer can also be operated manually directly on the device.

The lighting can be fully automatically switched on or off or dimmed at the desired time using adjustable time profiles.



Using the app, you can individually select the desired dimming level.



QUIET, ENERGY-SAVING AND VERSATILE

The modern electronics of the trailing edge dimming actuator enables operation without any noise development in comparison to older dimmers.

The low current consumption, which makes the device especially energy-efficient, is another plus.

Moreover, the dimming actuator can be used for many modern lamps (even for especially low loads):

- ✓ Dimmable LEDs
- ✓ Dimmable energy-saving lamps
- ✓ Traditional incandescent lamps
- ✓ High-voltage halogen lamps
- ✓ Low-voltage halogen lamps with electronic transformers

A SMART ALARM CLOCK

A relaxed start to the day: Dimmable lamps can be gently switched on automatically at sunrise or any desired time.

"ALEXA, TURN OFF THE LIGHTS!"

The pluggable dimmer can even be operated conveniently from the sofa - very simply with a voice command using Amazon Alexa or Google Assistant.

JUST GET STARTED

Assembly is child's play, by plugging into a standard socket - and you're done! Thanks to the compact design, the pluggable switch does not block the surrounding sockets.

Operation requires connection to one of the following solutions:

- Homematic IP access point with free smartphone app and free cloud service
- Third-party partner solutions

TECHNICAL SPECIFICATIONS

Supply voltage	230 V/50 Hz
Current consumption	0.35 A max.
Power consumption in standby	0.4 W
Max. switching capacity	80 VA
Minimum load	3 VA
Load type	Ohmic and capacitive lamp load
Dimming method	Trailing edge
Degree of protection	IP20
Ambient temperature	-10 to +55°C
Dimensions (W x H x D)	70 x 70 x 39 mm (not incl. mains plug)
Weight	138 g
Radio frequency band	868.0-868.6 MHz 869.4-869.65 MHz
Typical Range in open space	170 m

LOGISTICS DATA

Product reference	159046A0
EAN code	4047976590469
Short description	HmIP-PDT-CH
Packing unit	45
Packing dimensions	122 x 112 x 97 mm
Weight incl. packaging	265,3 g

PACKAGE CONTENTS

Homematic IP pluggable dimmer – trailing edge (CH)
Operating manual

INVISIBLE AND
SMART CONTROL
OF LIGHTS

Switch Actuator with Push-button Input – flush-mount

HmIP-FSI16

Control the lights smart while still using existing push-buttons or switches for operation as used to. This is possible with the easily retrofitted Homematic IP Switch Actuator.



homematic 
Smart Living, Simply Exciting.

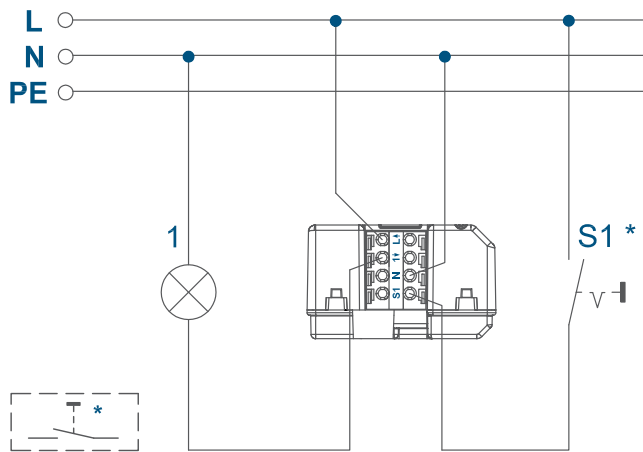

SUITABLE FOR MANY CONNECTED LOADS

- ✓ ohmic loads (14 A permanent/16 A for 15 min.)
- ✓ incandescent lamps (1500 W per channel)
- ✓ self-ballasted lamps (LED/compact fluorescent lamp) (200 W)
- ✓ HV halogen lamps (1500 W)
- ✓ LV halogen lamps with electronic transformer or iron core transformer (1500 W)
- ✓ fluorescent lamps uncompensated or parallel compensated (1500 W)
- ✓ electronic radiators and electric heating systems (8 A, 200,000 operations)

SMART LIGHT CONTROL

Switching of a connected light provides for the ideal lighting atmosphere in the smart home. Thanks to the high switching capacity, even large loads with up to 16 A can be switched.

TECHNICAL SPECIFICATIONS

Supply voltage	230 V/50 Hz
Standby power consumption	0.25 W
Max. switching capacity	3220 W permanent 3680 W for 15 minutes
Max. switching current	14 A permanent 16 A for 15 minutes
Relay	NO contact, 1-pole, μ contact
Cable type and cross section	rigid and flexible cable, 1.5-2.5 mm ²
Installation	only in switch boxes (device boxes) in accordance with DIN 49073-1 or junction boxes (surface-mounting boxes) in accordance with DIN 60670-1
Degree of protection	IP20
Ambient temperature	-10 to +55 °C
Dimensions (W x H x D)	54 x 33 x 41 mm
Weight	49 g
Radio frequency band	868.0-868.6 MHz 869.4-869.65 MHz
Typ. open area RF range	180 m

FLEXIBLE OPERATION

The integrated push-button input and wireless communication offer a large number of control options:

- ✓ Directly via standard 230 V push-buttons or switches
- ✓ Wirelessly using Homematic IP Push-buttons or Remote Controls
- ✓ Via the Homematic IP smartphone app

INVISIBLE INSTALLATION

Compact design for easy installation in flush-mounting boxes. Existing push-buttons/switches can be easily connected via the integrated input with screwless terminals. Double terminals for easy through-wiring.

The installation is also possible with surface-mounted junction boxes (e.g. ELS Spelsberg Abox 25) in protected outdoor areas, such as in garages or under a roof overhang.



EXTENDED OPERATION

With time profiles for individual configuration via the Homematic IP app, switching of lights can be adjusted to the daily routine of the user.

Furthermore, the switch actuator can be controlled conveniently via voice control (using Amazon Alexa or Google Assistant).

To enable operation, the device has to be connected with one of the following solutions:

- Homematic IP Access Point with free smartphone app and free cloud service
- Third-party solutions of partners

LOGISTICAL DATA

Product reference	154346A0
EAN code	4047976543465
Short description	HmIP-FSI16
Packing unit	90
Packing dimensions	122 x 112 x 48 mm
Weight incl. packaging	144 g

PACKAGE CONTENTS

Homematic IP Switch Actuator with Push-button Input – flush-mount
User manual

SMART SWITCHING
AND MEASURING
ENERGY
CONSUMPTION

Switch actuator and meter – flush mount

HmIP-FSM

This particularly compact, flush-mounted switch actuator and meter gives you smart control of connected loads, such as lights, while also measuring their energy consumption. The connected load can be conveniently and flexibly switched on or off via remote control, motion detector, Homematic IP app or voice command.



homematic **IP**
Smart living. Simply exciting.

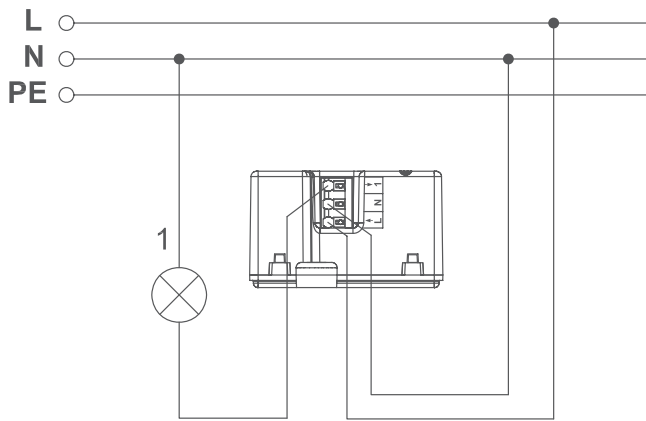

A neutral conductor is required for installation

SMART LIGHT SWITCHING

The switch actuator and meter makes it easy to switch the connected luminaire on and off to produce atmospheric lighting in your smart home.

The actuator is suitable for the following loads:

- ✓ Ohmic loads (5 A/1150 W)
- ✓ Light bulbs (5 A/1150 W)
- ✓ Self-ballasted lamps (200 W)
- ✓ HV halogen lamps (1150 W)
- ✓ Electronic transformers for NV halogen lamps (200W)
- ✓ Iron core transformers for NV halogen lamps (1150 W)
- ✓ Fluorescent lamps (uncompensated) (200 W)
- ✓ Fluorescent lamps (parallel compensated) (200 W)
- ✓ Electric radiators and other electric heating systems (ohmic load) (5 A /200.000 switching cycles)

TECHNICAL SPECIFICATIONS

Supply voltage	230 V/50 Hz
Current consumption	5 A max.
Power consumption in standby	0.2 W
Max. switching capacity	1150 W
Load type	load, $\cos\phi \geq 0.95$
Cable type and cross section	rigid and flexible cable, 0.75–1.5 mm ²
Measuring accuracy (performance)	measuring range: 0 to 1150 W resolution: 0.01 W accuracy: 1% ± 0.03 W of the measured value
Installation	only in switch boxes (device boxes) according to DIN 49073-1 or ELS Spelsberg junction boxes (surface-mounted boxes) according to DIN 60670-1 (e.g. Abox 25 and Abox 40)
Degree of protection	IP20
Ambient temperature	-10 to +55 °C
Dimensions (W x H x D)	54 x 33 x 41 mm
Weight	45 g
Radio frequency band	868.0–868.6 MHz 869.4–869.65 MHz
Typical radio free-field range	130 m

POWER CONSUMPTION UNDER CONTROL

With the metering function, the consumption values and costs of connected electrical appliances can be easily monitored via an app. This quickly identifies “power guzzlers” in your home and switches appliances on only when they are needed.

In addition, customised energy consumption monitoring automations can be set up in the app. For example, a push notification can be sent when the switch actuator and meter has exceeded a defined consumption value.

INVISIBLE INSTALLATION

Compact design for easy installation in common flush-mounted boxes. The screwless spring-loaded terminals make wiring particularly easy and secure.

Alternatively, it is also possible to install the device in surface-mounted distribution boxes (e.g. ELS Spelsberg Abox 25) in basement rooms or in protected outdoor areas.

FLEXIBLE OPERATION

- ✓ Wirelessly using Homematic IP push-buttons, or remote controls or motion detectors
- ✓ At any time via the Homematic IP smartphone app
- ✓ Via adjustable time profiles to automatic switch the lighting on or off at the desired time
- ✓ Automatic switching on and off at sunset and sunrise
- ✓ Easy operation via voice control (using Amazon Alexa or Google Assistant)

To enable operation, the device must be connected with one of the following solutions:

- Homematic IP Access Point with free smartphone app and free cloud service
- Third-party partner solutions

LOGISTICS DATA

Product reference	142721A0
EAN code	4047976427215
Short description	HmlIP-FSM
Packing unit	90
Packing dimensions	122 x 112 x 48 mm
Weight incl. packaging	118.0 g

PACKAGE CONTENTS

Homematic IP switch actuator and meter – flush mount
Operating manual

HIGH SWITCHING
CAPACITY AND PRECISE
CONSUMPTION
METERING

Switch actuator and meter (16 A) – flush mount

HmIP-FSM16

This particularly compact, flush-mounted switch actuator and meter gives you smart control of connected loads while also measuring their energy consumption. Thanks to its exceptionally high switching capacity, it is also suitable for use with large devices up to 16 A – without affecting the measuring accuracy.



homematic 
Smart living. Simply exciting.

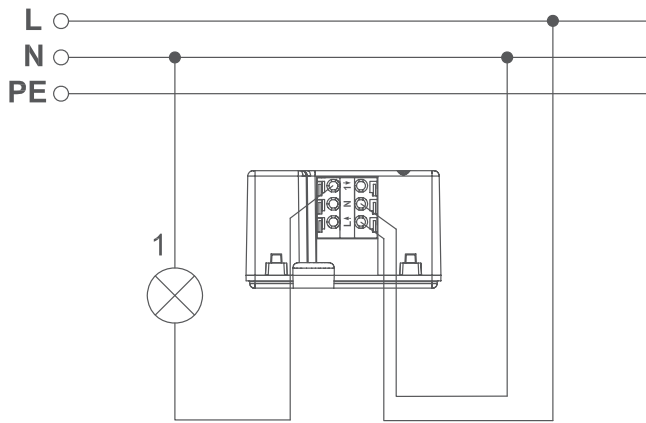

A neutral conductor is required for installation

SWITCHING AND METERING

With a switching capacity of 3,680 W for up to 20 minutes and a continuous load of 2,760 W, the switch actuator and meter is particularly suitable for large loads up to 16 A. Its high measuring accuracy also enables precise measurement of small loads, such as stand-by consumption.

The actuator is suitable for the following loads:

- ✓ Ohmic loads (16 A/3680 W)
- ✓ Light bulbs (16 A/3680 W)

TECHNICAL SPECIFICATIONS

Supply voltage	230 V/50 Hz
Current consumption	16 A max.
Power consumption in standby	0.2 W
Max. switching capacity	2760 W permanently 3680 W for 20 min
Load type	load, $\cos\phi \geq 0.95$
Cable type and cross section	rigid and flexible cable, 1.5–2.5 mm ² measuring range: 0 to 3680 W resolution: 0.01 W
Measuring accuracy (performance)	accuracy: 1% ± 0.03 W of the measured value in flush-mounted boxes (device boxes)
Installation	according to DIN 49073-1 and in ELS Spelsberg junction boxes (e.g. Abox 25 and Abox 40)
Degree of protection	IP20
Ambient temperature	5 to 35 °C
Dimensions (W x H x D)	54 x 33 x 41 mm
Weight	49 g
Radio frequency band	868.0–868.6 MHz 869.4–869.65 MHz
Typical radio free-field range	180 m

POWER CONSUMPTION UNDER CONTROL

With the metering function, the consumption values and costs of connected electrical appliances can be easily monitored via an app. This quickly identifies “power guzzlers” in your home and switches appliances on only when they are needed.

In addition, customised energy consumption monitoring automations can be set up in the app. For example, a push notification can be sent when the switch actuator and meter has exceeded a defined consumption value.

INVISIBLE INSTALLATION

Compact design for easy installation in common flush-mounted boxes. The screwless terminals make wiring particularly easy and secure.

Alternatively, it is also possible to install the device in surface-mounted distribution boxes (e.g. ELS Spelsberg Abox 25) in basement rooms or in protected outdoor areas.

FLEXIBLE OPERATION

- ✓ Wirelessly using Homematic IP push-buttons, or remote controls or motion detectors
- ✓ At any time via the Homematic IP smartphone app
- ✓ Via adjustable time profiles to automatic switch the lighting on or off at the desired time
- ✓ Automatic switching on and off at sunset and sunrise
- ✓ Easy operation via voice control (using Amazon Alexa or Google Assistant)

To enable operation, the device must be connected with one of the following solutions:

- Homematic IP Access Point with free smartphone app and free cloud service
- Third-party partner solutions

LOGISTICS DATA

Product reference	150239A0
EAN code	4047976502394
Short description	HmIP-FSM16
Packing unit	90
Packing dimensions	122 x 112 x 48 mm
Weight incl. packaging	118.0 g

PACKAGE CONTENTS

Homematic IP Switch Actuator and Meter (16 A) – flush-mount
Operating manual

HIGH
FUNCTIONALITY
IN THE SMALLEST
SPACE

Switch Actuator for DIN rail mount – 1 channel

HmIP-DRS11

The narrow switch actuator with a width of only 1 WM can easily be installed on a DIN rail to switch a channel from the distribution cabinet. Therefore, the device is ideal to replace trigger impulse switches. It is controlled directly via standard 230 V push-buttons, wirelessly via Homematic IP push-buttons or remote controls, and even via the smartphone app at any time.



Certified by VDE

homematic ^{IP}
Smart Living, Simply Exciting.

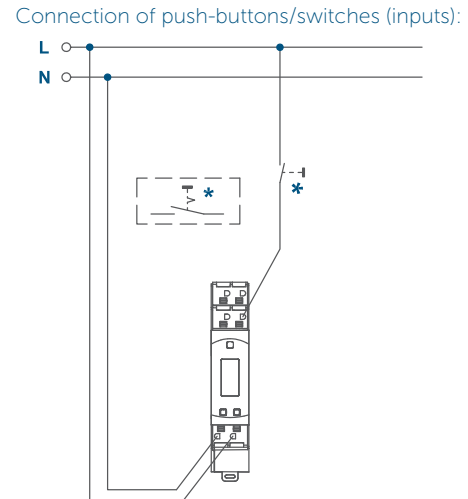
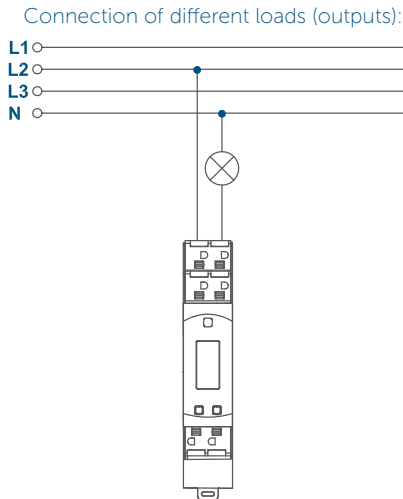

SUITABLE FOR MANY CONNECTED LOADS

- ✓ ohmic loads (10 A)
- ✓ incandescent lamps (1500 W per channel)
- ✓ self-ballasted lamps (LED/compact fluorescent lamp) (200 W)
- ✓ HV halogen lamps (1500 W)
- ✓ LV halogen lamps with electronic transformer or iron core transformer (1500 W)
- ✓ fluorescent lamps uncompensated or parallel compensated (1500 W)
- ✓ electronic radiators and electric heating systems (8 A, 200,000 switching cycles)

TWO FUNCTIONS IN ONE DEVICE

Not only does the switch actuator enable convenient switching of connected lights via an independent channel, it also replaces a conventional impulse switch.

EASY TO INSTALL

Connection to rigid or flexible cables is particularly easy thanks to the spring-loaded terminals. Even without programming, the function and cabling can be checked directly on the device during installation thanks to the illuminated display and the device buttons.

FLEXIBLE OPERATION

The connected lamp can be controlled flexibly via wireless push-buttons or remote controls as well as the Homematic IP app at any time, using time profiles for example. Also manual operation via conventional wired push-buttons is possible.

ADDED VALUE FOR A SMART HOME

Also suitable for expansions of the building (e.g. attics) and retrofitting. Can easily be installed in the distribution cabinet and the compact housing means it does not need much space. No intervention is required on the existing installation within the room. Existing switches and buttons can simply continue to be used.

Operation requires connection to one of the following solutions:

- Homematic IP Access Point with free smartphone app and free cloud service
- Third-party solutions of partners

TECHNICAL SPECIFICATIONS

Supply voltage	230 V~/50 Hz
Standby power consumption	300 mW typically (display lights off)
Relay	NO contact, 1-pole, μ contact, bistable
Switching voltage	230 V~
Current carrying capacity (device)	10 A
Cable type and cross section	rigid and flexible cable, 1.5-2.5 mm ²
Installation	on a mounting rail (DIN rail) according to EN 60715
Degree of protection	IP20
Ambient temperature	-5 to +40 °C
Dimensions (W x H x D)	18 x 90 x 69 mm (1 WM width)
Weight	81 g
Radio frequency band	868.0-868.6 MHz 869.4-869.65 MHz
Typ. open area RF range	300 m

LOGISTICAL DATA

Product reference	154684A0
EAN code	4047976546848
Short description	HmIP-DRS1
Packing unit	144
Packing dimensions	122 x 93 x 36 mm
Weight incl. packaging	184,8 g

PACKAGE CONTENTS

Homematic IP Switch Actuator for DIN rail mount – 1 channels
User manual

SMART EXPANSION,
FLEXIBLE SWITCHING
OF LIGHTS

Switch Actuator for DIN rail mount – 4 channels

HmIP-DRSI4

Switches up to four channels from the distribution board: The solid housing design offers professional and easy installation to standard DIN rails. A wide range of control options are then available directly via standard 230 V push-buttons, wirelessly via Homematic IP buttons or remote controls, and even via the smartphone app at any time.



Certified by VDE

homematic ^{IP}
Smart Living, Simply Exciting.

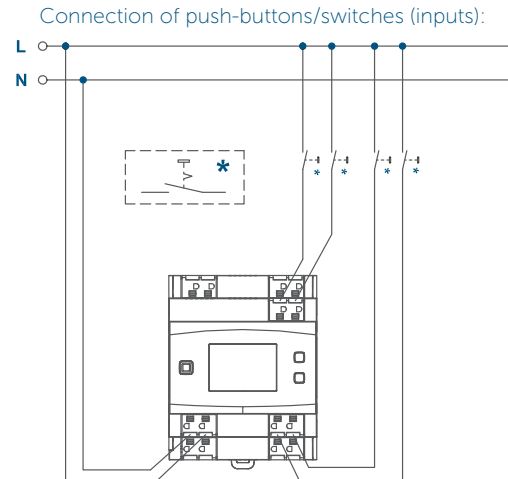
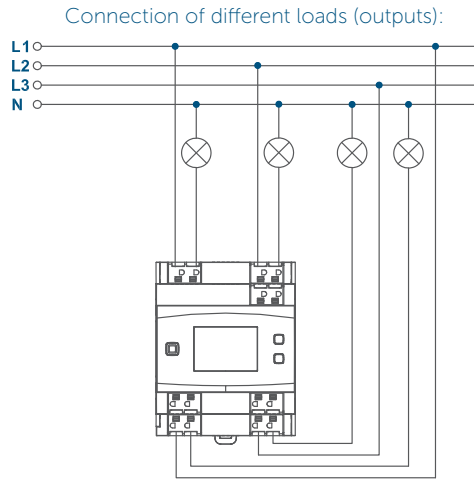

SUITABLE FOR MANY CONNECTED LOADS

- ✓ ohmic loads (16 A per channel)
- ✓ incandescent lamps (1500 W per channel)
- ✓ self-ballasted lamps (LED/compact fluorescent lamp) (200 W per channel)
- ✓ HV halogen lamps (1500 W per channel)
- ✓ LV halogen lamps with electronic transformer or iron core transformer (1500 W per channel)
- ✓ fluorescent lamps (uncompensated or parallel compensated) (1500 W per channel)
- ✓ electronic radiators and electric heating systems (8 A, 200,000 switching cycles per channel)

SMART LIGHT CONTROL

Conveniently switch up to four connected lights via independent channels on and off, for the perfect ambient lighting in your smart home.

EASY TO INSTALL

Mounting to standard DIN rails is particularly easy using the spring tension clamps and connectors supplied. Each channel can be assigned to a different phase, thereby enabling the independent control of each individual channel. Even without programming, the function and cabling can be checked directly on the device during installation thanks to the illuminated display and the device buttons.

FLEXIBLE OPERATION

Connected lights can be controlled flexibly via wireless push-buttons or remote controls as well as the Homematic IP app at any time, using time profiles for example. Also manual operation via conventional wired push buttons is possible.

ADDED VALUE FOR A SMART HOME

Also suitable for expansions of the building (e.g. attics) and retrofitting. Easy installation into the distribution board. No intervention is required on the existing installation within the room. Existing switches and buttons can simply continue to be used. Ideal to replace trigger impulse switches.

Operation requires connection to one of the following solutions:

- Homematic IP Access Point with free smart-phone app and free cloud service
- Third-party solutions of partners

TECHNICAL SPECIFICATIONS

Supply voltage	230 V~/50 Hz
Standby power consumption	280 mW typically (display lights off)
Relay	NO contact, 1-pole, μ contact, bistable
Switching voltage	230 V~
Current carrying capacity (device):	Σ 64 A
Cable type and cross section	rigid and flexible cable, 1.5-2.5 mm ²
Installation	on a mounting rail (DIN rail) according to EN 60715
Degree of protection	IP20
Ambient temperature	-5 to +40 °C
Dimensions (W x H x D)	72 x 90 x 69 mm (4 WM width)
Weight	221 g
Radio frequency band	868.0-868.6 MHz 869.4-869.65 MHz
Typ. open area RF range	190 m

LOGISTICAL DATA

Product reference	154431A0
EAN code	4047976544318
Short description	HmlP-DRSI4
Packing unit	45
Packing dimensions	122 x 112 x 97 mm
Weight incl. packaging	392,3 g

PACKAGE CONTENTS

Homematic IP Switch Actuator for DIN rail mount – 4 channels
User manual

SMART EXPANSION
FOR CONVENIENT
CONTROL OF BLINDS

Blind Actuator for DIN rail mount – 4 channels

HmIP-DRBLI4

Controls up to four blinds, shutters or awnings from the distribution board: The solid housing design offers professional and easy installation to standard DIN rails. A wide range of control options for shading elements are then available directly via standard 230 V push-buttons, wirelessly via Homematic IP buttons or remote controls, and even via the smartphone app at any time.



Certified by VDE

homematic ^{IP}
Smart Living, Simply Exciting.

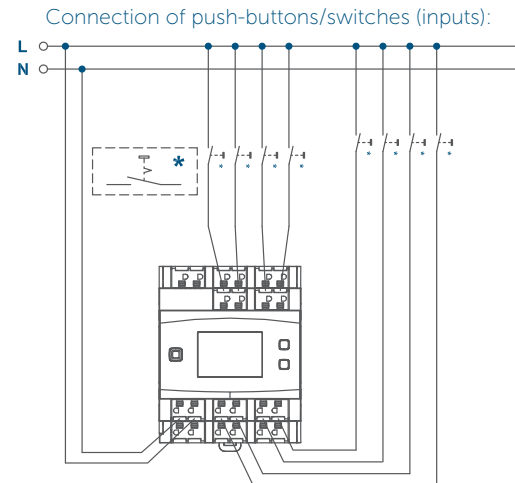
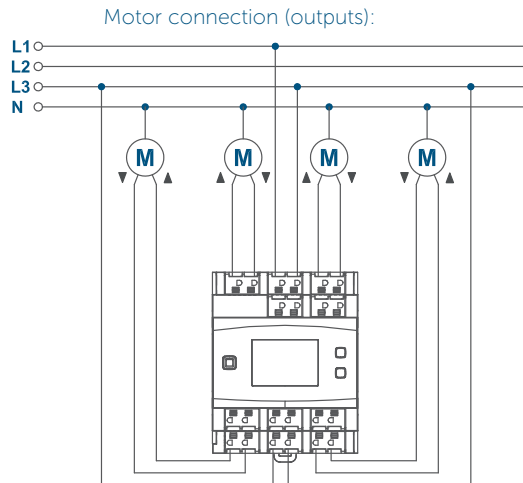

SMART CONTROL FOR SHUTTERS AND BLINDS

Move up to four connected blinds, shutters or awnings up and down via individual channels for greater convenience and security in a smart home.

SMART CONTROL AT ALL TIMES

With configurable time profiles, blinds are moved up or down automatically and can thus be adapted to the inhabitants' daily routines. You can control your blinds or shutters either on the move via smartphone, manually using the installed push-buttons or even via voice control.

Operation requires connection to one of the following solutions:

- Homematic IP Access Point with free smartphone app and free cloud service
- Third-party solutions of partners

TECHNICAL SPECIFICATIONS

Supply voltage	230 V~/50 Hz
Standby power consumption	280 mW typically (display lights off)
Load type	motor load (M)
Relay	changeover contact, μ contact
Switching voltage	230 V~
Current carrying capacity (channel)	2.2 A
Cable type and cross section	rigid and flexible cable, 1.5-2.5 mm ²
Installation	on a mounting rail (DIN rail) according to EN 60715
Degree of protection	IP20
Ambient temperature	-5 to +40 °C
Dimensions (W x H x D)	72 x 90 x 69 mm (4 WM width)
Weight	256 g
Radio frequency band	868.0-868.6 MHz 869.4-869.65 MHz
Typ. open area RF range	190 m

BLIND CONTROL DEPENDING ON THE SUN POSITION

Wake up feeling relaxed in the morning or secure your home in the evening: Blinds can be controlled automatically based on sunrise and sunset. Intelligent heat protection prevents rooms from overheating in the summer with automatic shutter control.

EASY TO INSTALL

Connection to rigid or flexible cables is particularly easy thanks to the spring-loaded terminals. Each channel can be connected to a different phase. The device provides independent control of each individual channel. Even without programming, the function and cabling can be checked directly on the device during installation thanks to the illuminated display and the device buttons.

ADDED VALUE FOR A SMART HOME

Also suitable for expansions of the building (e.g. attics) and retrofitting. Easy installation into the distribution board. No intervention is required on the existing installation within the room. Existing switches and buttons can simply continue to be used. Suitable for all standard tube motors.

LOGISTICAL DATA

Product reference	154362A0
EAN code	4047976543625
Short description	HmIP-DRBLI4
Packing unit	45
Packing dimensions	122 x 112 x 97 mm
Weight incl. packaging	427 g

PACKAGE CONTENTS

Homematic IP Blind Actuator for DIN rail mount – 4 channels
User manual

SMART EXPANSION,
COMFORTABLE
DIMMING OF LIGHTS

Dimming Actuator for DIN rail mount – 3 channels

HmIP-DRDI3

Offers dimming of up to three lamps from the distribution board: The solid housing design offers professional and easy installation to standard DIN rails. A wide range of control options are then available directly via standard 230 V push-buttons, wirelessly via Homematic IP buttons or remote controls, and even via the smartphone app at any time.



Certified by VDE

homematic ^{IP}
Smart Living, Simply Exciting.

Connection of dimmable lights (outputs):

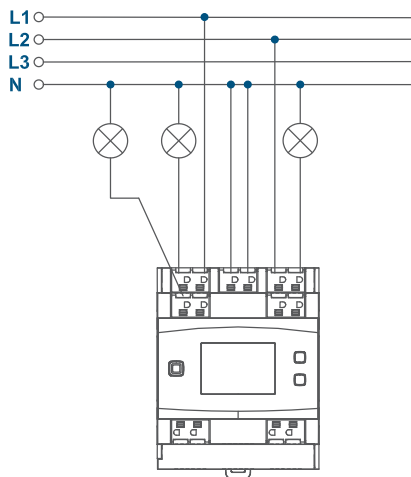

Connection of push-buttons/switches (inputs):

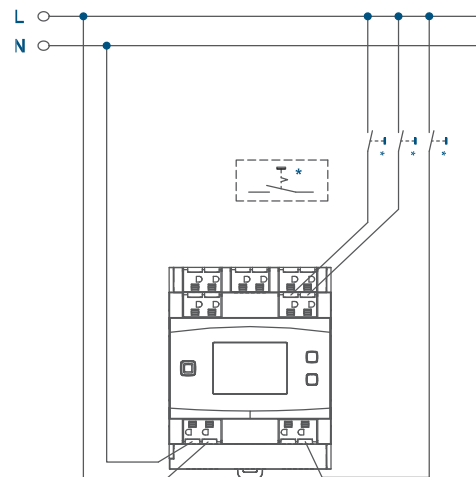

SMART CONTROL AND DIMMING OF LIGHTS

Almost infinitely variable dimming and switching of up to three connected lights via independent channels for the perfect lighting atmosphere in a smart home

SUITABLE FOR A LARGE NUMBER OF ILLUMINANTS

- ✓ Dimmable LEDs
- ✓ Dimmable energy-saving lamps
- ✓ Incandescent lamps
- ✓ HV halogen lamps
- ✓ NV halogen lamps with electronic transformer

Operation requires connection to one of the following solutions:

- Homematic IP Access Point with free smart-phone app and free cloud service
- Third-party solutions of partners

TECHNICAL SPECIFICATIONS

Supply voltage	230 V~/50 Hz
Standby power consumption	0,5 W (typically)
Channel 1-3:	
Minimum load	3 VA
Max. switching capacity	200 VA
Dimming method	Reverse phase control
Cable type and cross section	rigid and flexible cable, 0.75-2.5 mm ²
Installation	on a mounting rail (DIN rail) according to EN 60715
Degree of protection	IP20
Ambient temperature	-5 to +40 °C
Dimensions (W x H x D)	72 x 90 x 69 mm (4 WM width)
Weight	200 g
Radio frequency band	868.0-868.6 MHz
	869.4-869.65 MHz
Typ. open area RF range	190 m

EASY TO INSTALL

Connection to rigid or flexible cables is particularly easy thanks to the spring-loaded terminals. Even without programming, the function and cabling can be checked directly on the device during installation thanks to the illuminated display and the device buttons.

FLEXIBLE OPERATION

Connected lights can be controlled flexibly via wireless push-buttons or remote controls as well as the free Homematic IP app at any time, using time profiles for example. Also, manual operation via conventional wired push buttons is possible.

ADDED VALUE FOR A SMART HOME

Also suitable for expansions of the building (e.g. attics) and retrofitting. Easy installation into the distribution board. No intervention is required on the existing installation within the room. Existing switches and buttons can simply continue to be used. Ideal to replace trigger impulse switches.

LOAD TYPES PER CHANNEL 1-3

Incandescent lamp load	200 W
Self-ballasted lamps (LED/compact fluorescent lamp)	100 W
HV halogen lamps	200 W
Electronic transformers for NV halogen lamps	200 W

LOGISTICAL DATA

Product reference	154434A0
EAN code	4047976544349
Short description	HmIP-DRDI3
Packing unit	45
Packing dimensions	122 x 112 x 97 mm
Weight incl. packaging	371.3 g

PACKAGE CONTENTS

Homematic IP Dimming Actuator for DIN rail mount – 3 channels
User manual

SIMPLE INTEGRATION
AND INTELLIGENT
LIGHT SWITCHING

Switch Module for brand switches – International

HmIP-BSM-I

The Switch Module for brand switches – International allows lighting to be controlled the smart and simple way. The invisible flush-mounted solution can be integrated directly into many switch series with adapters, and blends perfectly into the existing switch design. Use the Homematic IP app to conveniently set up and control your lights via your smartphone, time profile or pushbutton.

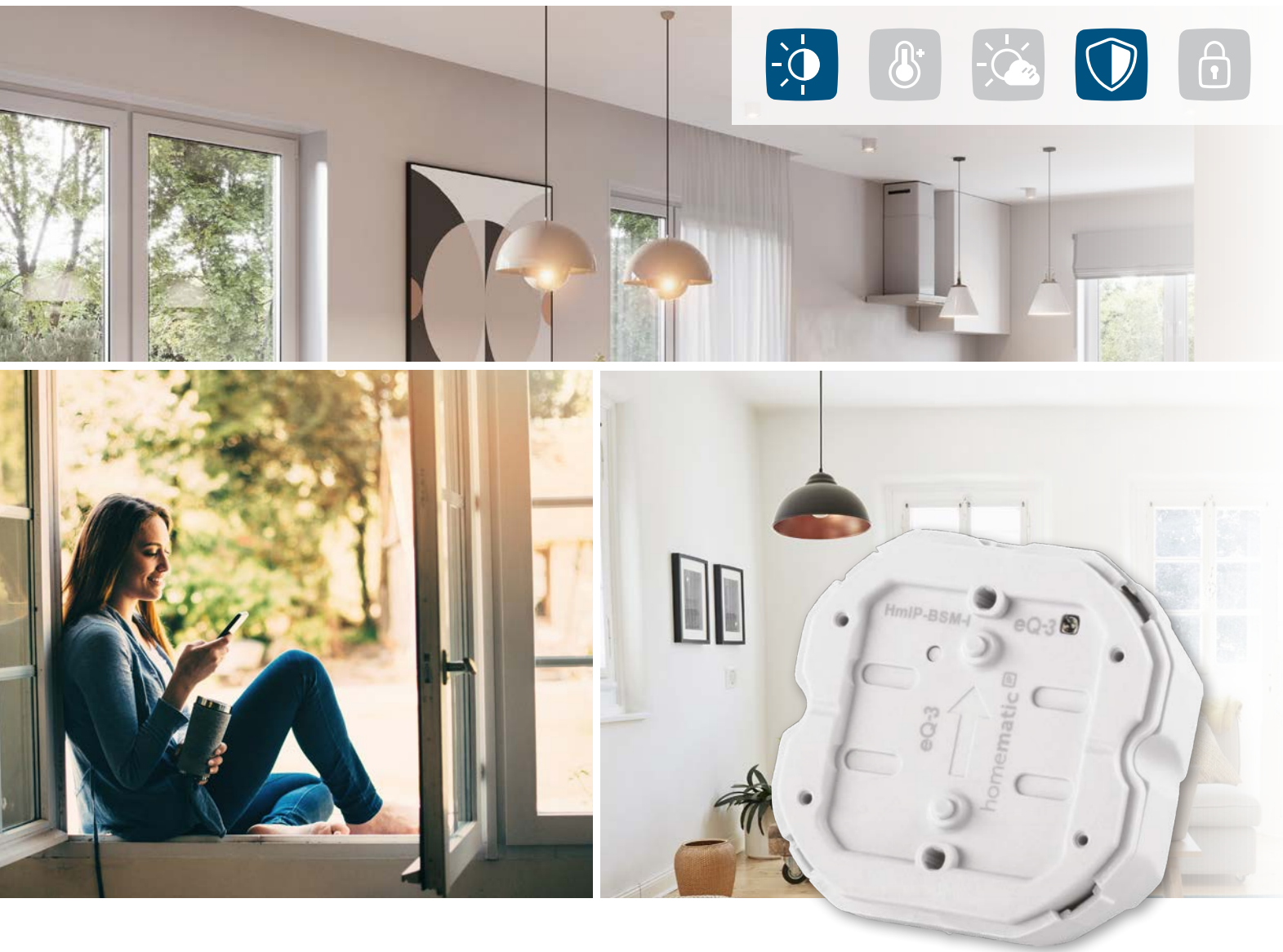

homematic ^{IP}
Smart living. Simply exciting.

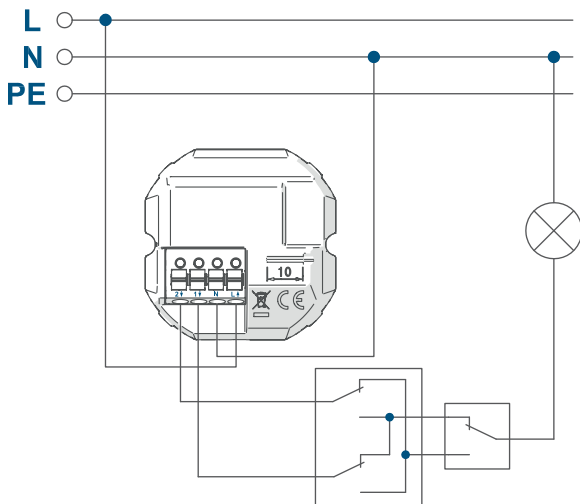

Example: Cross-connection
A neutral conductor is required for installation

INTELLIGENT LIGHT SWITCHING

The connected lights can be conveniently switched on and off to create the ideal lighting mood in your smart home.

The switch module can be used not just for switching off but also for intermediate and changeover switching, and recognises the switching status of all switching points by means of the integrated measuring function.

JUST GET STARTED

The compact design allows installation in standard flush-mounted boxes, with no special electronics box required. The screwless terminals make wiring particularly easy and secure. The connection is identical to a manual switch and so can be done by any installer.

TECHNICAL SPECIFICATIONS

Supply voltage	230 V/50 Hz
Current consumption	6 A max.
Power consumption in standby	0.2 W
Minimum load for cross-connection or two-way circuits	1 W
Maximum switching capacity	1380 W
Load type	Ohmic load
Relay	Changeover contact
Cable type and cross section	rigid and flexible cable, 0.75 - 2.5 mm ²
Installation	only in Legrand Batibox-type switch boxes conforming to DIN 49073-1, and Agro flush-mounted back boxes
Degree of protection	IP20
Ambient temperature	-5 to +40 °C
Dimensions (W x H x D)	52 x 52 x 31 mm
Weight	55 g
Radio frequency band	868.0-868.6 MHz 869.4-869.65 MHz
Typical range in open space	280 m

INVISIBLE INSTALLATION

Integration into existing switch series is very easy by using the existing frames and rockers. With a corresponding adapter*, the switch module can be integrated into many leading manufacturers' (e.g. Legrand, Schneider Electric and Feller) popular switch series. An overview of the compatible manufacturers is available at www.homematic-ip.com.

*Adapter must be purchased separately

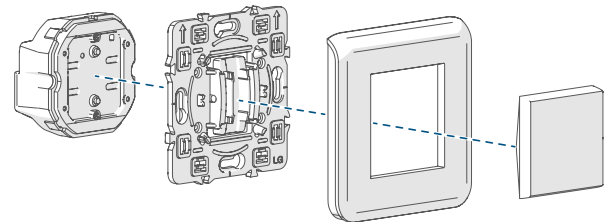

Homematic IP Switch Module for brand switches Suitable adapter Frame (example) Rocker (example)

FLEXIBLE OPERATION

- ✓ Directly via the existing switch series
- ✓ Wirelessly using Homematic IP push-buttons, or remote controls or motion detectors
- ✓ At any time via the Homematic IP app
- ✓ Via adjustable time profiles to automatic switch the lighting on or off at the desired time
- ✓ Easy operation via voice control (using Amazon Alexa or Google Assistant)

Operation requires connection to one of the following solutions:

- Homematic IP access point with free smartphone app and free cloud service
- Third-party partner solutions

LOGISTICS DATA

Product reference	155999A0A
EAN code	4047976559992
Short description	HmIP-BSM-I
Packing unit	90
Packing dimensions	122 x 112 x 48 mm
Weight incl. packaging	146.6 g

PACKAGE CONTENTS

Homematic IP switching module for brand switches – international
Operating manual

THE PERFECT LIGHT-
ING MOOD IN YOUR
SMART HOME

Dimming Actuator for Brand Switches – International

HmlP-BDT-I

The dimming actuator for brand switches – international from Homematic IP makes control of dimmable lamps smart. The invisible flush-mounted solution can be flexibly retrofitted. This means that existing switch series can simply continue to be used. The lights can then be conveniently controlled via your smartphone, fully-automatically via a time profile or in the usual way with buttons.

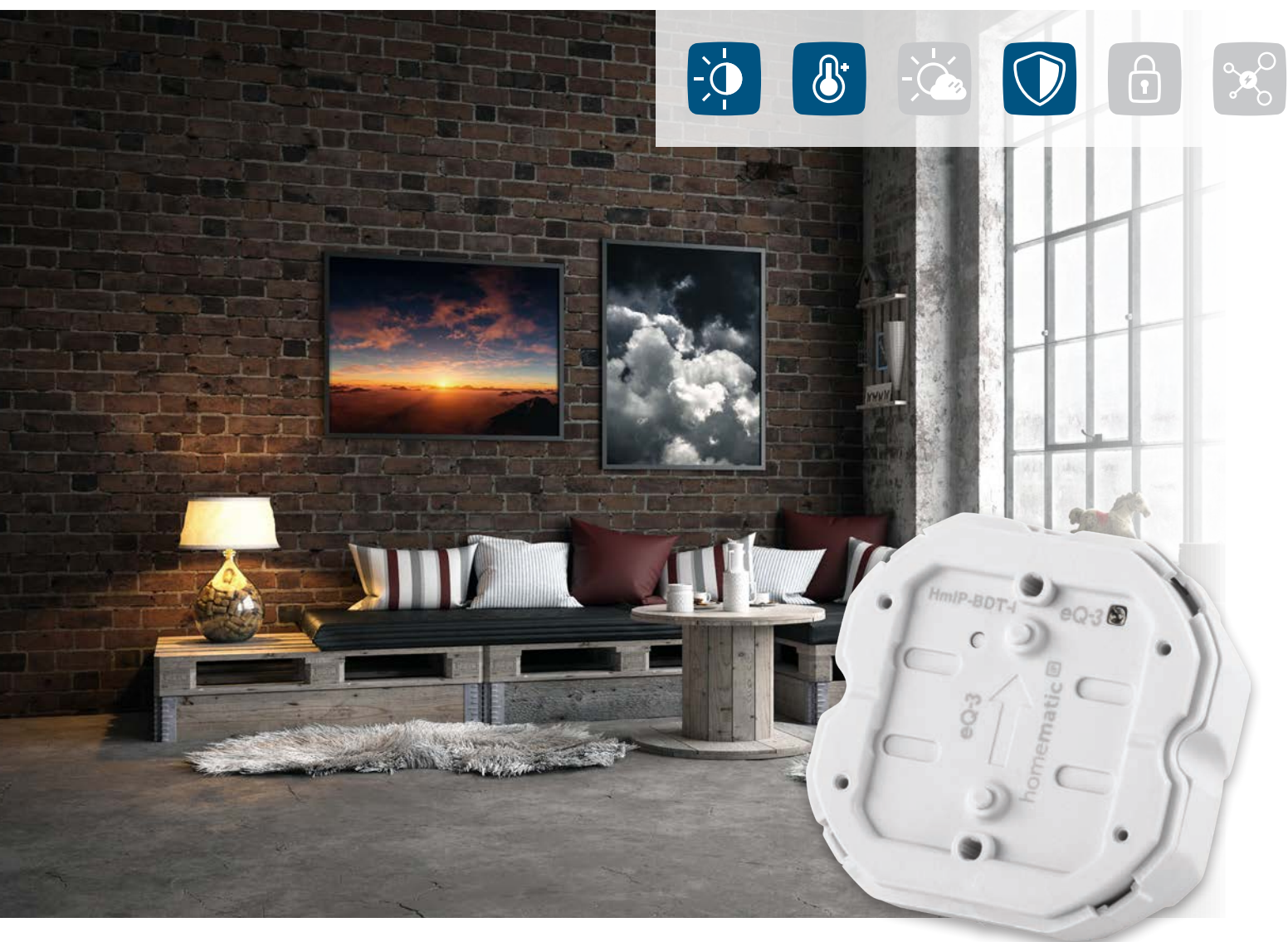

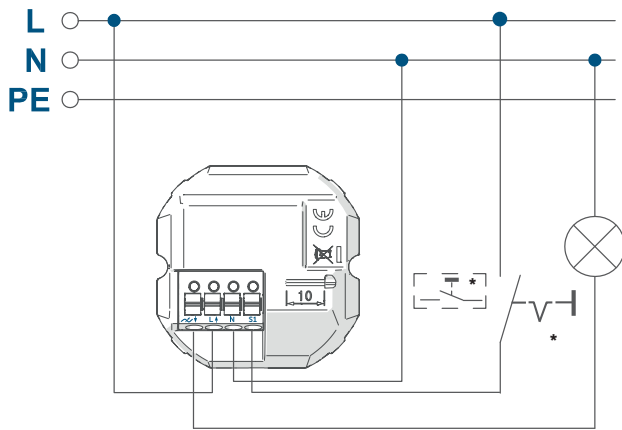

A neutral conductor is required for installation

INTELLIGENT LIGHT SWITCHING AND DIMMING

Almost infinitely variable dimming and switching of the connected lights to create the ideal lighting mood in your smart home. Using the Homematic IP app, you can individually select the desired dimming level.

Control is flexible, by means of a smart phone, a wireless push-button or remote control, using the existing switch series or conveniently by means of voice control. The lighting can also be fully automatically switched on or off at the desired time using adjustable time profiles.

SUITABLE FOR MANY LAMPS

- ✓ Dimmable LEDs
- ✓ Dimmable energy-saving lamps
- ✓ Incandescent lamps
- ✓ HV halogen lamps
- ✓ Low-voltage halogen lamps with electronic transformers

TECHNICAL SPECIFICATIONS

Supply voltage	230 V/50 Hz
Current consumption	0.35 A
Minimum load	3 VA
Maximum switching capacity	80 VA
Power consumption in standby	0.4 W
Dimming method	Reverse phase control
Load type	ohmic and capacitive lamp load
Cable type and cross section	rigid and flexible cable, 0.75 - 2.5 mm ²
Installation	only in Legrand Batibox-type, switch boxes conforming to DIN 49073-1, and Agro flush-mounted back boxes
Degree of protection	IP20
Ambient temperature	-5 to +40 °C
Dimensions (W x H x D)	52 x 52 x 31 mm
Weight	47 g
Radio frequency band	868.0-868.6 MHz 869.4-869.65 MHz
Typical Range in open space	280 m

A SMART ALARM CLOCK

A relaxed start to the day: Dimmable lamps can be slowly switched on automatically at sunrise or any desired time.

INSTALLED CONCEALED IN THE EXISTING DESIGN

Integration into existing switch series is very easy by using the existing frames and rockers. With a corresponding adapter*, the switching module can be integrated into many leading manufacturers' (e.g. Legrand, Schneider Electric and Feller) popular switch series. An overview of the compatible manufacturers is available at www.homematic-ip.com.

*Adapter must be purchased separately

SIMPLE TO INSTALL

The compact design allows installation in standard flush-mounted boxes, with no special electronics box required. The screwless terminals make wiring particularly easy and secure. The connection is identical to a manual switch and so can be done by any installer.

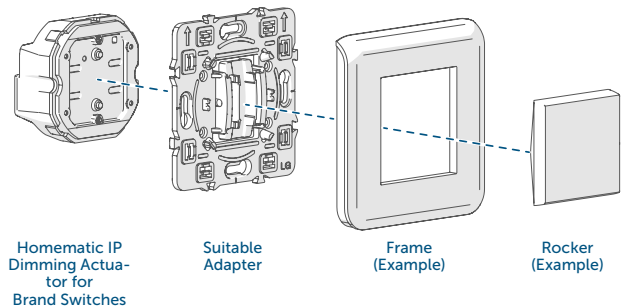

Operation requires connection to one of the following solutions:

- Homematic IP access point with free smartphone app and free cloud service
- Third-party partner solutions

LOGISTICS DATA

Product reference	159157A0
EAN code	4047976591572
Short description	HmlP-BDT-I
Packing unit	90
Packing dimensions	122 x 112 x 48 mm
Weight incl. packaging	145,1 g

PACKAGE CONTENTS

Homematic IP Dimming Actuator for Brand Switches – International
Operating manual

A COMFORTABLE HOME
AND SECURITY THANKS
TO INTELLIGENT BLIND
AND SHUTTER CONTROL

Blind Actuator for Brand Switches – International

HmIP-BBL-I

The blind and shutter actuator for brand switches – international from Homematic IP makes control of electrical blinds and shutters smart. The invisible flush-mounted solution can be flexibly retrofitted. This means that existing switch series can simply continue to be used. The blinds can then be conveniently controlled via your smartphone, fully-automatically via a time profile or in the usual way with buttons.



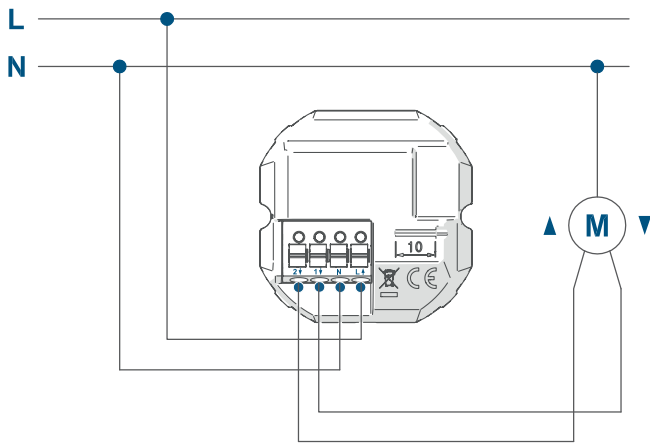

A neutral conductor is required for installation

SMART CONTROL ROUND THE CLOCK

With adjustable time profiles, Venetian blinds, external Venetian blinds shutters or awnings go up or down automatically to adapt to the residents' daily routines or weather conditions. In the case of Venetian blinds and external Venetian blinds, the desired slat position can also be set exactly.

Control is flexible, by means of a smart phone, a wireless push-button or remote control, using the existing switch series or conveniently by means of voice control.

SHUTTER CONTROL ACCORDING TO THE SUN'S POSITION

Whether it's for a relaxed wake-up in the morning or securing the home at dusk: Blinds or shutters can be

Operation requires connection to one of the following solutions:

- Homematic IP access point with free smartphone app and free cloud service
- Third-party partner solutions

TECHNICAL SPECIFICATIONS

Supply voltage	230 V/50 Hz
Current consumption	2.2 A max.
Power consumption in standby	0.2 W
Max. switching capacity	500 VA
Load type	motor load
Relay	1x NO contact, 1x changeover contact
Cable type and cross section	rigid and flexible cable, 0.75-2.5 mm ²
Degree of protection	IP20
Installation	only in Legrand Batibox-type, switch boxes conforming to DIN 49073-1, and Agro flush-mounted back boxes
Ambient temperature	-5 to +40 °C
Dimensions (W x H x D)	52 x 52 x 31 mm
Weight	55 g
Radio frequency band	868.0-868.6 MHz 869.4-869.65 MHz
Typical Range in open space	175 m

controlled automatically to coincide with the sunrise and sunset. Thanks to automatic shading, intelligent thermal protection prevents rooms being overheated in summer.

INSTALLED CONCEALED IN THE EXISTING DESIGN

Integration into existing switch series is very easy by using the existing frames and rockers. With a corresponding adapter*, the blind and shutter actuator can be integrated into many leading manufacturers' (e.g. Legrand, Schneider Electric and Feller) popular switch series. An overview of the compatible manufacturers is available at www.homematic-ip.com.

*Adapter must be purchased separately

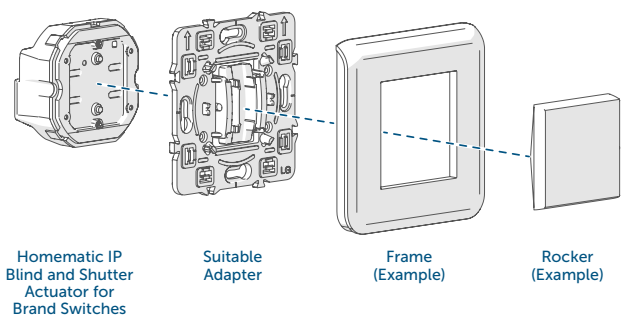

GREATER SECURITY

Automatic lowering when darkness falls or when you are not at home secures windows and doors and can also suggest that you are in.

SIMPLE TO INSTALL

Easy to install with automatic calibration drive via the app. Compact design for installation in standard flush-mounted boxes. Suitable for all standard tube motors.

FLEXIBLE OPERATION

- ✓ Directly via the existing switch series
- ✓ Wirelessly using Homematic IP push-buttons, or remote controls or motion detectors
- ✓ At any time via the Homematic IP app
- ✓ Via adjustable time profiles to automatic switch the lighting on or off at the desired time
- ✓ Easy operation via voice control (using Amazon Alexa or Google Assistant)

LOGISTICS DATA

Product reference	158682A0
EAN code	4047976586820
Short description	HmlIP-BBL-I
Packing unit	90
Packing dimensions	122 x 112 x 48
Weight incl. packaging	144,1 g

PACKAGE CONTENTS

Homematic IP Blind and Shutter Actuator for Brand Switches – International Operating manual

INDIVIDUAL LIGHTING
MOOD AND COLOUR
TEMPERATURE
CONTROL

LED Controller – RGBW

HmIP-RGBW

The Homematic LED Controller can be used in a variety of ways in the smart home. Up to four channels allow LED strips to be individually controlled, creating the desired lighting mood. Brightness, colour and time schedules are set up individually via the Homematic IP app for convenient switching.



homematic ^{IP}
Smart living. Simply exciting.

CONVENIENT & FLEXIBLE CONTROL

The LED Controller is easy to use via the Homematic IP App. For example, switch-on times of the LED strips can be conveniently set up via time schedules.

Different dimming times can also be set to control the brightness of the connected LED strips depending on the time of day.

INDIVIDUAL LIGHTING AND COLOUR MOODS

Besides the dimming times, the light temperature (tunable white) and colour moods (RGB, RGBW) can also be defined.

HCL (human centric lightning) mode adapts the light to the natural daylight pattern. This means that the light changes from reddish to bluish during the day, and back again in the evening. The artificial replication of the daylight pattern supports the human biorhythm so that productivity is increased during the day and relaxation is stimulated in the evening.

The Dim2Warm operating mode simulates the dimming behaviour of a traditional incandescent lamp. The darker the luminaire is set, the warmer the light. The brighter the luminaire is set, the colder the light.

VERSATILE OPERATION

The LED Controller can be easily controlled by remote control, voice control or via the Homematic IP App.

EASY TO INSTALL

The robust housing allows the Homematic IP LED Controller to be mounted on a wall or in a suspended ceiling. A power supply unit suitable for the LED strips used must be purchased separately.

FOUR DIFFERENT OPERATING MODES

The Homematic IP LED Controller offers four different connection options:

Monocolour LED strip connection

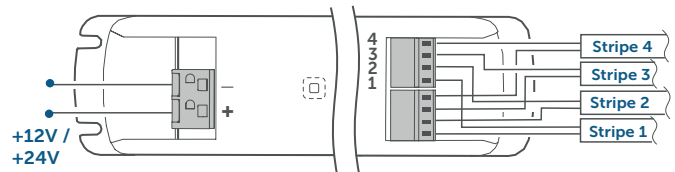

Tunable white connection

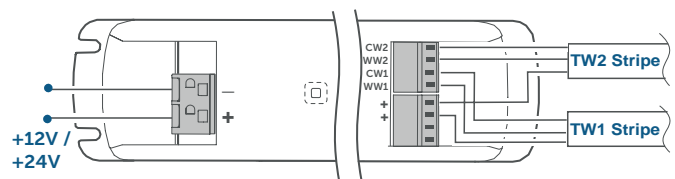

RGB strip connection

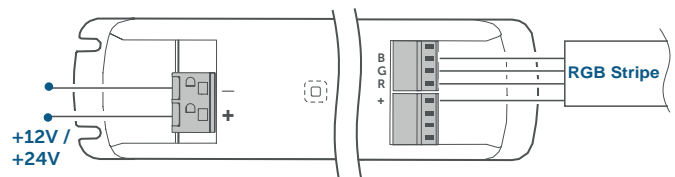

RGBW strip connection

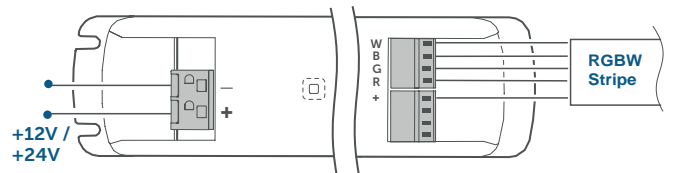

Operation requires connection to one of the following solutions:

- Homematic IP access point with free smartphone app and free cloud service
- Third-party supplier partner solutions

TECHNICAL SPECIFICATIONS

Supply voltage	12 - 24 VDC
Current consumption	8.5 A (max. 2.1 A per channel)
PWM base frequency	1 kHz
Power consumption in standby	60 mW @ 24 V
Cable cross section	
Input terminals	0.5-2.5 mm ²
Output terminals	0.2-1.5 mm ²
Degree of protection	IP20
Ambient temperature	5 to 40 °C
Dimensions (W x H x D)	170 x 40 x 26 mm
Weight	79 g
Radio frequency band	868.0-868.60 MHz 869.4-869.65 MHz
Typical range in open space	260 m

LOGISTICS DATA

Product reference	157662A0
EAN code	4047976576623
Short description	HmIP-RGBW
Packing unit	72
Packing dimensions	184 x 92 x 48 mm
Weight incl. packaging	190,2 g

PACKAGE CONTENTS

Homematic IP LED Controller – RGBW
Operating manual

HOMEMATIC IP AND
DALI LAMPS IDEALLY
COMBINED

DALI Gateway

HmIP-P-DRG-DALI

Atmospheric lighting conditions for your personal needs throughout the house. Dim the light using the Homematic IP app, the remote control or a switch. The DALI Gateway reliably controls DALI lamps in your smart home. It enables easy installation on a mounting rail and can be integrated into existing systems.



homematic 
Smart living. Simply exciting.

SMART LIGHT SWITCHING AND DIMMING

With a DALI Gateway, you can perfectly switch and dim up to 32 DALI lamps in your home.

The DALI Gateway can be easily retrofitted in an existing installation with DALI lamps and is concealed in the distribution cabinet.

Homematic IP pushbuttons and switches that have already been installed can continue to be used and integrated without any problems.

THE VALUE ADDED FOR A SMART HOME

Once installed, DALI lamps can be assigned to the channels of the Gateway and controlled in up to 16 lamp groups.

FLEXIBLE OPERATION OF THE DALI LAMPS

DALI lamps can now be switched on and off and dimmed with many Homematic IP devices, such as a Homematic IP radio remote control.

Using the free Homematic IP app, the DALI lamps in your smart home can also be easily operated from your smart phone.

EASY INSTALLATION

Installation is on standard rail mountings in house- and sub-distribution boards.

The spring-loaded terminals enable simple connection of the DALI lamps both to rigid and flexible cables.

The DALI lamps can be controlled and tested immediately after connection to the bus without training using the large illuminated LC display of the Gateway.

SUITABLE FOR MANY DALI LAMPS

- ✓ Fluorescent lamps (DT0)
- ✓ Discharge lamps (DT2)
- ✓ Low-voltage halogen lamps (DT3)
- ✓ Dimmers for incandescent lamps (DT4)
- ✓ Conversion to DC (0-10V, DT5)
- ✓ LED modules (DT6)
- ✓ Switching function (DT7)
- ✓ Colour and colour temperature control (DT8)

(Not compatible with DALI control devices)

TECHNICAL SPECIFICATIONS

Supply voltage	230 V~/50 Hz
Current consumption	45 mA max.
Power consumption in standby	1 W typ. (display lighting off)
Cable type and cross section	rigid and flexible cable, 0.75-2.5 mm ²
Installation	on mounting rail (DIN rail) according to EN 60715
Degree of protection	IP20
Ambient temperature	-5 to +40 °C
Dimensions (W x H x D)	72 x 90 x 69 mm (4 TE)
Weight	294 g
DALI	
Rated voltage	16 VDC (typ.)
Current	130 mA (typ.), 250 (max.)
No. of DALI units	32
No. of DALI groups	16

Operation requires connection to one of the following solutions:

- Homematic IP Access Point with free smartphone app and free cloud service
- Third-party supplier partner solutions

LOGISTICS DATA

Product reference	157283A1A
EAN code	4047976572847
Short description	HmlP-P-DRG-DALI
Packing unit	36
Packing dimensions	122 x 140 x 97 mm
Weight incl. packaging	450 g

PACKAGE CONTENTS

Homematic IP DALI Gateway
Operating manual

SMART BLIND
CONTROL FOR
INCREASED COMFORT
AND SECURITY

Blind Actuator – flush-mount

HmIP-FBL

The Homematic IP Blind Actuator offers intelligent control of electric blinds and awnings. The invisible solution for flush-mounted installation can be easily retrofitted. Afterwards, blinds are controlled via smartphone, automatically via individual time profiles or – as used to – via standard push-buttons.

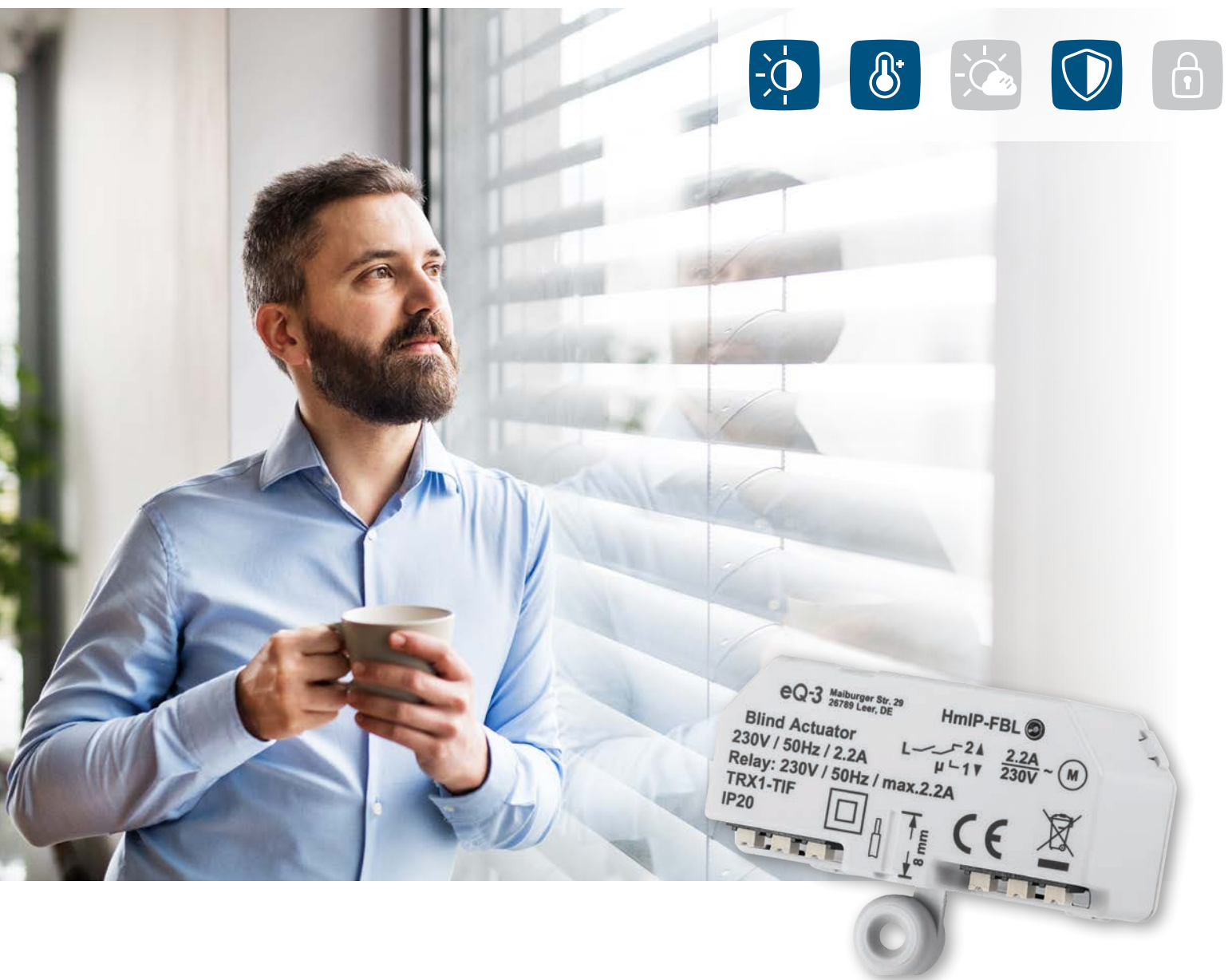

homematic 
Smart Living, Simply Exciting.



SMART CONTROL AT ALL TIMES

Adjustable time profiles allow blinds, interior blinds, shutters or awnings to move up or down automatically. Thus, they are adapted to the daily routine of the user or to the current weather conditions. For blinds, even the exact slats position can be adjusted.

The device is controlled flexibly by smartphone, via push-buttons or remote controls or simply using voice control (via Amazon Alexa or Google Assistant).

Operation requires connection to one of the following solutions:

- Homematic IP Access Point with free smartphone app and free cloud service
- Third-party solutions of partners

TECHNICAL SPECIFICATIONS

Supply voltage	230 V/50 Hz
Current consumption	2.2 A max.
Standby power consumption	0.2 W
Max. switching capacity	500 VA
Load type	motor load
Relay	1x NO contact, 1x changeover contact
Cable type and cross section	rigid and flexible cable, 0.75-1.5 mm ² only in switch boxes (device boxes) in accordance with DIN 49073-1 or surface-mounting boxes in accordance with DIN 60670-1 (e.g. Abox 025 or Abox 040)
Installation	
Degree of protection	IP20
Ambient temperature	-10 to +55 °C
Dimensions (W x H x D)	54 x 33 x 41 mm
Weight	40 g
Radio frequency band	868.0-868.6 MHz 869.4-869.65 MHz
Typ. open area RF range	180 m

SHUTTER CONTROL DEPENDING ON THE SUN POSITION

Wake up feeling relaxed in the morning or secure your home in the evening: Shutters can be controlled automatically in accordance with the sunrise and sunset. Automatic shading offers smart insulation to avoid rooms from overheating during summer.

INCREASED SECURITY

Shutters are moved down automatically when it is getting dark or if you are away from home – this secures windows and doors and can also protect your privacy or suggest someone is present.

GET STARTED

Easy start-up thanks to guided calibration run via the app. Suitable for all standard tube motors.

INVISIBLE INSTALLATION

Compact design for easy installation in flush-mounting boxes. Supports the connection of standard push-buttons via screwless clamps for local operation.

The installation is also possible with surface-mounted junction boxes (e.g. ELS Spelsberg Abox 25) in protected outdoor areas, such as in garages or under a roof overhang.

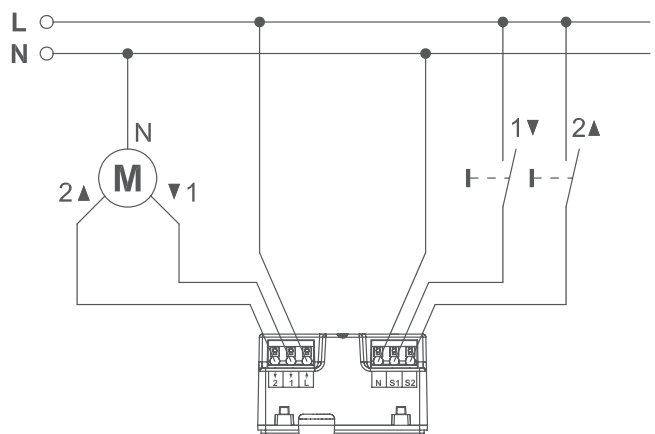

For installation, a neutral conductor is required.

LOGISTICAL DATA

Product reference	151398A0
EAN code	4047976513987
Short description	HmIP-FBL
Packing unit	90
Packing dimensions	122 x 112 x 48 mm
Weight incl. packaging	121.2 g

PACKAGE CONTENTS

Homematic IP Blind Actuator – flush-mount
User manual

SMART SHUTTER
CONTROL FOR
INCREASED COMFORT
AND SECURITY

Shutter Actuator – flush-mount

HmIP-FROLL

The Homematic IP Shutter Actuator offers intelligent control of electric shutters and awnings. The invisible solution for flush-mounted installation can be easily retrofitted. Afterwards, shutters are controlled via smartphone, automatically via individual time profiles or – as used to – via standard push-buttons.



homematic 
Smart Living, Simply Exciting.

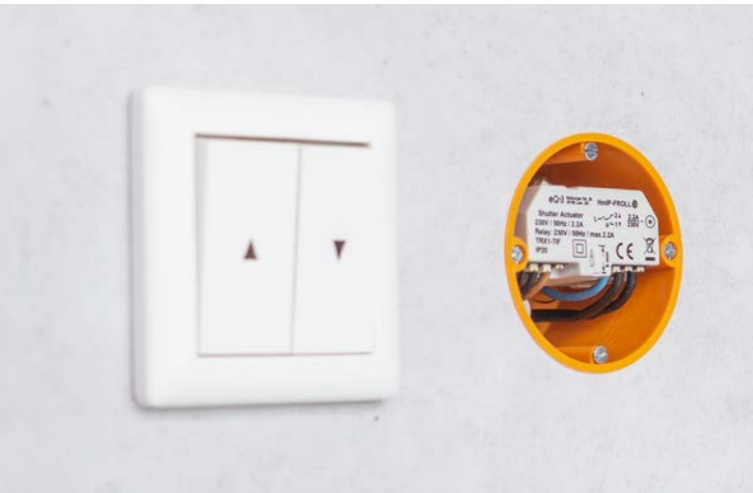

SMART CONTROL AT ALL TIMES

Adjustable time profiles allow shutters or awnings to move up or down automatically. Thus, they are adapted to the users' daily routine or to the current weather conditions.

The device is controlled flexibly by smartphone, via push-buttons or remote controls or simply using voice control (via Amazon Alexa or Google Assistant).

Operation requires connection to one of the following solutions:

- Homematic IP Access Point with free smartphone app and free cloud service
- Third-party solutions of partners

TECHNICAL SPECIFICATIONS

Supply voltage	230 V/50 Hz
Current consumption	2.2 A max.
Standby power consumption	0.2 W
Max. switching capacity	500 VA
Load type	motor load
Relay	1x NO contact, 1x changeover contact
Cable type and cross section	rigid and flexible cable, 0.75-1.5 mm ²
Installation	only in switch boxes (device boxes) in accordance with DIN 49073-1 or surface-mounting boxes in accordance with DIN 60670-1 (e.g. Abox 025 or Abox 040)
Degree of protection	IP20
Ambient temperature	-10 to +55 °C
Dimensions (W x H x D)	54 x 33 x 41 mm
Weight	40 g
Radio frequency band	868.0-868.6 MHz 869.4-869.65 MHz
Typ. open area RF range	180 m

SHUTTER CONTROL DEPENDING ON THE SUN POSITION

Wake up feeling relaxed in the morning or secure your home in the evening: Shutters can be controlled automatically in accordance with the sunrise and sunset. Automatic shading offers smart insulation to avoid rooms from overheating during summer.

INCREASED SECURITY

Shutters are moved down automatically when it is getting dark or if you are away from home – this secures windows and doors and can also protect your privacy or suggest someone is present.

GET STARTED

Easy start-up thanks to guided calibration run via the app. Suitable for all standard tube motors.

INVISIBLE INSTALLATION

Compact design for easy installation in flush-mounting boxes. Supports the connection of standard push-buttons via screwless clamps for local operation.

The installation is also possible with surface-mounted junction boxes (e.g. ELS Spelsberg Abox 25) in protected outdoor areas, such as in garages or under a roof overhang.

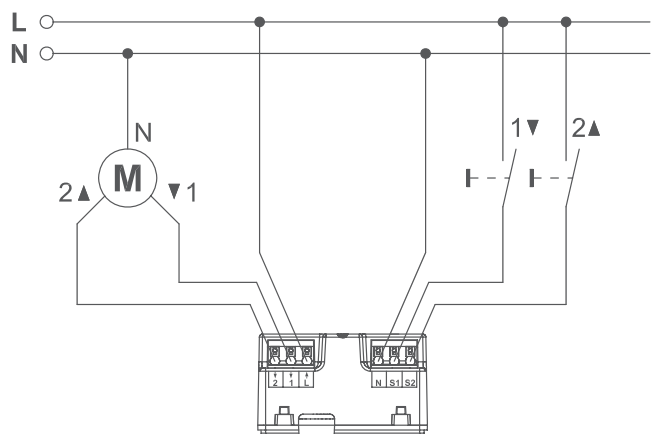

For installation, a neutral conductor is required.

LOGISTICAL DATA

Product reference	151347A0
EAN code	4047976513475
Short description	HmIP-FROLL
Packing unit	90
Packing dimensions	122 x 112 x 48 mm
Weight incl. packaging	121.2 g

PACKAGE CONTENTS

Homematic IP Shutter Actuator – flush-mount
User manual

ADJUST VENTILATION
AND LIGHTING TO
SUIT ALL YOUR
NEEDS

Universal actuator – 0-10 V

HmIP-WUA

The mains-powered Homematic IP Universal actuator can be used in a variety of ways in the smart home. The 0-10 V and 1-10 V interfaces allow individual regulation of controlled living space ventilation systems (KWL) or analogue controllable dimmers for creating the right lighting mood. Brightness and time profiles are set up individually via the Homematic IP app for convenient switching.



homematic ^{IP}
Smart Living, Simply Exciting.

TWO PARALLEL SWITCHING OUTPUTS

The mains-powered Universal actuator has a switching output with a 0-10 V interface, which can be used to conveniently control, for example, electronic ballasts or controlled living space ventilation systems (KWL). It is also possible to connect a consumer (e.g. dimmer) to the 1-10 V interface connected in parallel.

Connecting a 0-10 V device, e.g. KWL

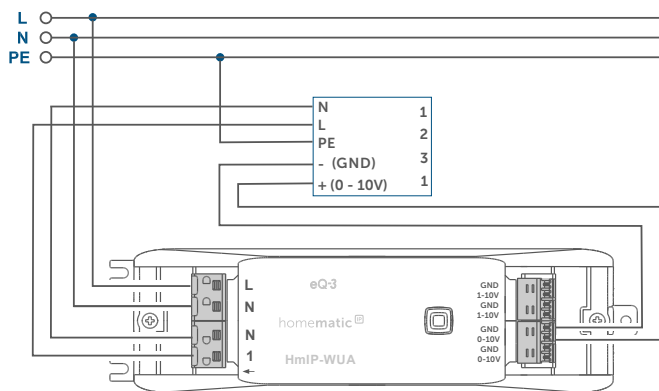

Connecting a 1-10 V dimmer

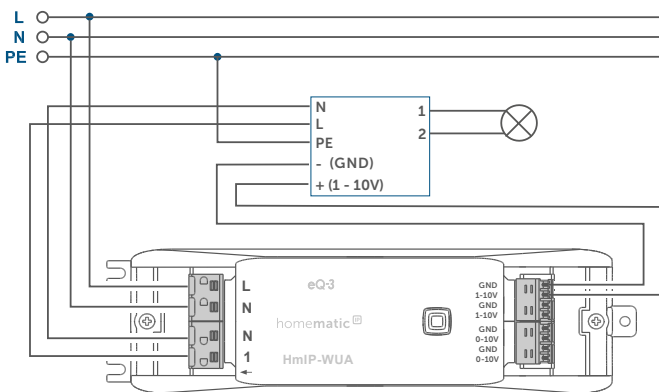

TECHNICAL SPECIFICATIONS

Supply voltage	230 V~/50 Hz
Current consumption	8 A max./16 mA (typically)
Switching voltage	230 V~
Power consumption in standby	200 mW
Cable cross section	
230 V terminals	1.5-2.5 mm ²
0-10 V terminals	0.25-1.5 mm ²
Degree of protection	IP20
Ambient temperature	5 to 35 °C
Dimensions (W x H x D)	51 x 31 x 187 mm
Weight	145 g
Radio frequency band	868.0-868.60 MHz 869.4-869.65 MHz
Typical range in open space	240 m
Relay	NO contact, 1-pole, μ contact

CONVENIENT & FLEXIBLE CONTROL

The Universal actuator is easy to control via the Homematic IP app. For example, KWL controllers can be conveniently set up via time profiles.

An additional paired Homematic IP wireless pushbutton can also be used to easily provide surge ventilation at the touch of a button. While ventilation is at the normal level during the day, the system can be set in such a way as to reduce it at night in order to prevent ventilation noise.

Lights can also be switched on or off via time profiles and with the desired dimming level.

ADDITIONAL RELAY

As soon as a conventional consumer is connected, this can additionally be switched on or off with the aid of the relay alongside the power supply. Unlike conventional actuators, the connected device can thus be completely de-energised.

EASY TO INSTALL

The robust housing allows the Homematic IP Universal actuator to be mounted on a wall or in a suspended ceiling. For this purpose, the device can be fastened with commercially available screws and dowels using the fastening lugs on the side.

Operation requires connection to one of the following solutions:

- Homematic IP Access point with free smartphone app and free cloud service
- Third-party supplier partner solutions

LOGISTICS DATA

Product reference	154761A0
EAN code	4047976547616
Short description	HmIP-WUA
Packing unit	48
Packing dimensions	281 x 91 x 48 mm
Weight incl. packaging	281.2 g

PACKAGE CONTENTS

Homematic IP universal actuator 0-10 V
Operating manual

Switch Circuit Board

HmIP-PCBS



Enables the wireless switching, e.g. of a switch or button input, 12 V signalling device or LEDs, in the extra-low voltage range. Thanks to the compact design the device can be flexibly installed into existing devices and own projects.

FLEXIBLE APPLICATION WITHIN THE SMART HOME

The switch circuit board can be used in almost all areas of a smart home. It is suitable for switching conventional domestic appliances, lighting installations or garage door drives. Connected devices can be switched on and off comfortably via the Homematic IP app or a remote control.

Operation requires connection to one of the following solutions:

- Homematic IP Access Point with free smartphone app and free cloud service
- Third-party solutions of partners

- ✓ The miniature relay provides a switching capacity of up to 30 V/1 A
- ✓ If the miniature relay is not required it can simply be broken off and only the open collector switching output with 30 V/0.5 A can be used
- ✓ Can be used to extend the range of the radio signal
- ✓ Convenient and individual voice control (e.g. via Amazon Alexa or Google Assistant)

TECHNICAL SPECIFICATIONS

Supply voltage	5 to 25 VDC
Current consumption without relay	50 mA max.
Current consumption with relay	70 mA max.
Relay	changeover contact, 1-pole, μ contact
Load type	ohmic load
Switching voltage (max.)	30 V
Switching current (max.)	1 A (miniature relay) and 0.5 A (open collector switching output)
Cable type and cross section	rigid and flexible cable, 0.75 to 1.0 mm ²
Ambient temperature (operation)	-10 to +35 °C
Dimensions (W x H x D)	28 x 48 x 21 mm (incl. relay)
Weight	13 g
Radio frequency band	868.0-868.6 MHz 869.4-869.65 MHz
Typical open area RF range	350 m

LOGISTICAL DATA

Product reference	150776A0
EAN code	4047976507764
Short description	HmIP-PCBS
Packing unit	144
Packing dimensions	122 x 93 x 36 mm
Weight incl. packaging	74.2 g

PACKAGE CONTENTS

Homematic IP Switch Circuit Board
User manual

ALWAYS AT HAND
FOR FLEXIBLE USE

Key Ring Remote Control – 4 buttons

HmIP-KRC4

The compact Homematic IP Remote Control is ideal for a variety of functions, in the home and outdoors. Always within reach, it can be used as a universal remote control to control devices and system functions within the Homematic IP smart home system.



homematic ^{IP}
Smart Living, Simply Exciting.



DIVERSE AND DURABLE OPERATION

The four keys of the Homematic IP Key Ring Remote Control can be adapted to your individual preferences via the Homematic IP smartphone app. Depending on the assignment of keys, it is possible to control multiple Homematic IP devices and functions. The four buttons allow you to configure each of them individually and independently of each other. A standard AAA battery provides energy for up to two years (typ.).

CONVENIENT REMOTE CONTROL, AT HOME AND ON THE MOVE

With its compact design, the small remote control fits into every trouser pocket – or on your key ring. Thus, it is ideal for operation at home, in outdoor areas or in your car when coming home.

POWERFUL SENSOR

Reliable operation within an ambient temperature between $-10\text{ }^{\circ}\text{C}$ and $+55\text{ }^{\circ}\text{C}$. Therefore, the device can cope with any everyday situation. The wide radio range of up to 200 metres also enables, for example, the exterior lights or garage door to be switched directly from the car.

STURDY HOUSING DESIGN

The housing is made of halogen-free, fibreglass-reinforced plastic, making the remote control particularly resistant and stable. This optimises the remote control for use on a key ring. Each button press is confirmed directly via the integrated multicolour LED.

Operation requires connection to one of the following solutions:

- Homematic IP Access Point with free smartphone app and free cloud service
- Third-party solutions of partners

TECHNICAL SPECIFICATIONS

Supply voltage	1x 1.5 V LR03/micro/AAA
Battery life	2 years (typ.)
Degree of protection	IP20
Ambient temperature	-10 to $+55\text{ }^{\circ}\text{C}$
Dimensions (W x H x D)	38 x 75 x 14 mm
Weight	38 g (incl. batteries)
Radio frequency band	868.0-868.6 MHz / 869.4-869.65 MHz
Typical open area RF range	200 m

LOGISTICAL DATA

Product reference	140740A0
EAN code	4047976407408
Short description	HmlP-KRC4
Packing unit	144
Packing dimensions	122 x 93 x 36 mm
Weight incl. packaging	100.5 g

PACKAGE CONTENTS

Homematic IP Key Ring Remote Control – 4 buttons
Key ring
1.5 V LR03/micro/AAA battery
User manual

INTUITIVE OPERATION
FOR A LARGE NUMBER
OF SMART HOME
FUNCTIONS

Remote Control – 8 buttons

HmIP-RC8

The multifunctional remote control with four button pairs is always at hand and perfectly designed for convenient control of devices and system functions in the Homematic IP smart home. Thanks to individual allocation of button functions, there are almost no limits to the range of applications for the remote control.



homematic ^{IP}
Smart Living, Simply Exciting.

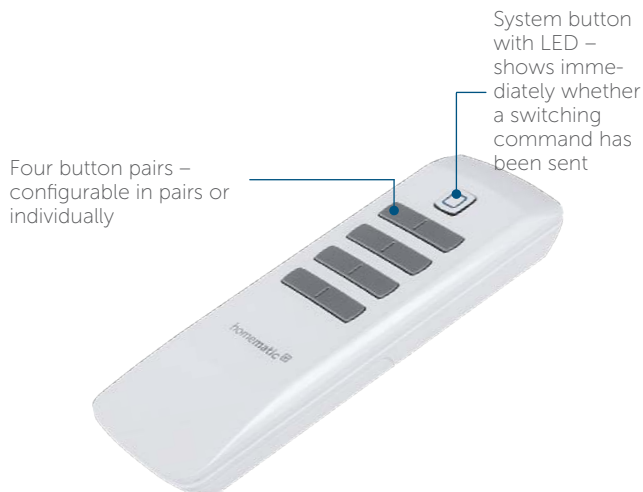

SMART HOME CONTROL AT THE TOUCH OF A BUTTON

The smartphone is not always close at hand to control Homematic IP devices or functions. In such cases, the universally applicable remote control proves to be particularly practical: devices/functions that are often used in the smart home can be controlled at the touch of a button.

INDIVIDUAL CONFIGURATION

The eight push-buttons of the remote control can be configured individually or in pairs to perfectly suit individual needs. The "Groups" and "Automation" functions of the Homematic IP smartphone app offer a wide range of solutions for this purpose, from dimming individual light sources and activating eco mode to controlling complex scenarios within the smart home system.

FLEXIBLE AND RELIABLE APPLICATION

Thanks to battery operation and a wide radio range, the remote control can be used anywhere in the house. A replaceable labelling field at the bottom of the remote control provides a clear overview of which functions or devices have been assigned to the buttons.

Operation requires connection to one of the following solutions:

- Homematic IP Access Point with free smartphone app and free cloud service
- Third-party solutions of partners

TECHNICAL SPECIFICATIONS

Supply voltage	2x 1.5 V LR03/micro/AAA
Battery life	2 years (typ.)
Degree of protection	IP20
Ambient temperature	5 to 35 °C
Dimensions (W x H x D)	46 x 131 x 19 mm
Weight	78 g
Radio frequency band	868.0-868.6 MHz / 869.4-869.65 MHz
Typical open area RF range	300 m

LOGISTICAL DATA

Product reference	142307A0
EAN code	4047976423071
Short description	HmlP-RC8
Packing unit	72
Packing dimensions	184 x 93 x 48 mm
Weight incl. packaging	174.0 g

PACKAGE CONTENTS

Homematic IP Remote Control – 8 buttons
 1.5 V LR03/micro/AAA batteries (2x)
 Labelling template
 User manual

VARIOUS
FUNCTIONS
IN ONE DEVICE

Wall-mount Remote Control – 2 buttons

HmIP-WRC2 | HmIP-WRC2-A

The flexible wall-mount remote control offers the right solution for every application in the smart home. One or more functions can be triggered simultaneously at the push of a button. Thanks to battery operation, the smart push-button can be easily mounted at any desired location or integrated into existing switch series.

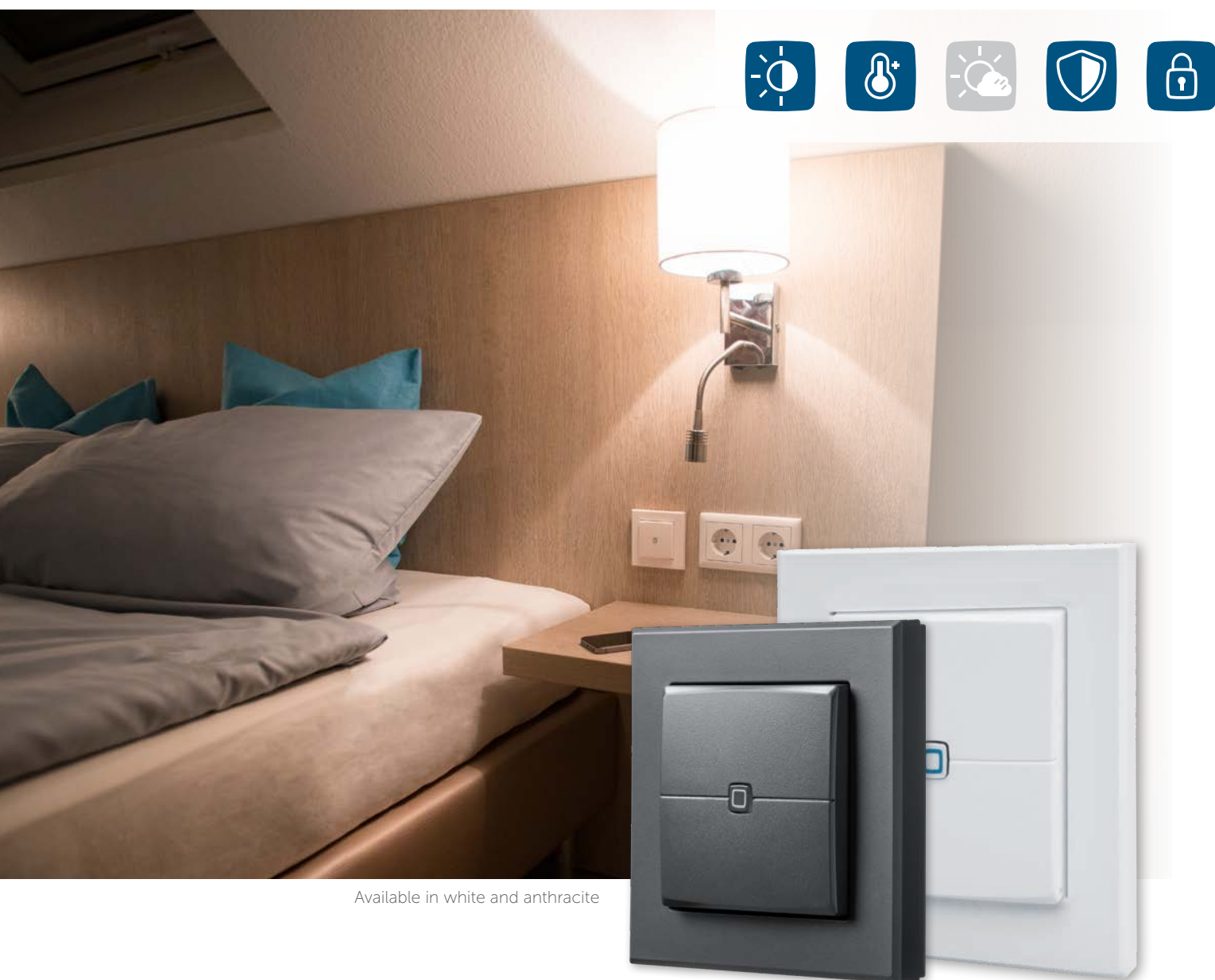

Available in white and anthracite

homematic ^{IP}
Smart Living, Simply Exciting.

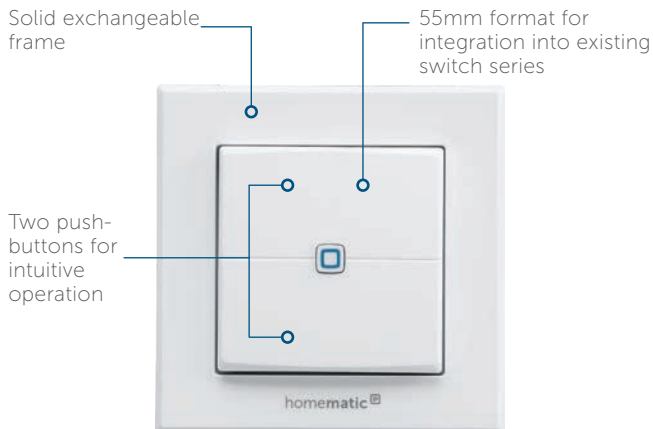

MODULAR DESIGN FOR HIGH FLEXIBILITY

Thanks to its modular design, the wall-mount remote control offers individual use:

- ✓ Adhesive or screw mounting in the supplied clip-on frame with enclosed mounting material
- ✓ Integration into existing switches with 55 mm frames of the most common manufacturers

Examples:



- ✓ Installation on a free flush-mounted box with corresponding mounting plate
- ✓ Integration into Homematic IP Desk Stand (HmIP-DS55)
- ✓ As an alternative to battery operation, the wall-mount remote control can also be supplied with 230 V via the Homematic IP Power Supply Unit for brand switches (HmIP-BPS-2).

TECHNICAL SPECIFICATIONS

Supply voltage	2x 1.5 V LR03/micro/AAA
Battery life	4 years (typ.)
Degree of protection	IP20
Ambient temperature	5 to 35 °C
Dimensions (W x H x D)	
Without frame:	55 x 55 x 17 mm
Including frame:	86 x 86 x 19 mm
Weight	82 g (including batteries)
Radio frequency band	868.0-868.6 MHz 869.4-869.65 MHz
Typ. open area RF range	200 m

THE IDEAL FUNCTION FOR EACH APPLICATION

Two intuitive push-buttons for comfortable control of devices or system functions in your smart home: The device can be used to switch light sources on or off, activate or deactivate the eco mode or to move shutters up or down.

PERFECT SOLUTION FOR ENTRANCE AREAS

Multiple functions at the touch of a button: When leaving the house, for example, all the lights can be switched off and the eco mode for your radiators can be activated. Activating or deactivating of the protection mode via the wall-mount remote control also ensures a secure feeling in the smart home.

QUICK AND EASY INSTALLATION

Easy installation without any wiring effort thanks to battery operation and radio communication. The device can be placed where it is needed. It is ideal for mounting on walls, glass or furniture, for example – without the need to lay any power cables. Only the supplied adhesive strips or screws are required for installation. Thanks to residue-free removal of the adhesive strips, the wall-mount remote control is even suitable for rented property.

To enable operation, the device has to be connected with one of the following solutions:

- Homematic IP Access Point with free smartphone app and free cloud service
- Third-party solutions of partners

LOGISTICAL DATA

Version	White	Anthracite
Product reference	140665A0	159881A0
EAN code	4047976406654	4047976598816
Short description	HmIP-WRC2	HmIP-WRC2-A
Packing unit	90	90
Packing dimensions	122 x 112 x 48 mm	122 x 112 x 48 mm
Weight incl. packaging	195,0 g	195,0 g

PACKAGE CONTENTS

Homematic IP Wall-mount Remote Control – 2 buttons
 Clip-on frame and mounting plate
 Mounting accessories
 1.5 V LR03/micro/AAA batteries (2x)
 User manual

FLEXIBLE CONTROL,
COMPACT DESIGN

Wall-mount Remote Control – 6 buttons

HmIP-WRC6 | HmIP-WRC6-A

The flexible wall-mount remote control offers the right solution for a large number of different applications in the smart home: Three pairs of buttons can be used to trigger several functions at the same time, according to the user's personal needs. Thanks to battery operation, the push-button can be easily mounted at any desired location or integrated into existing switch series.

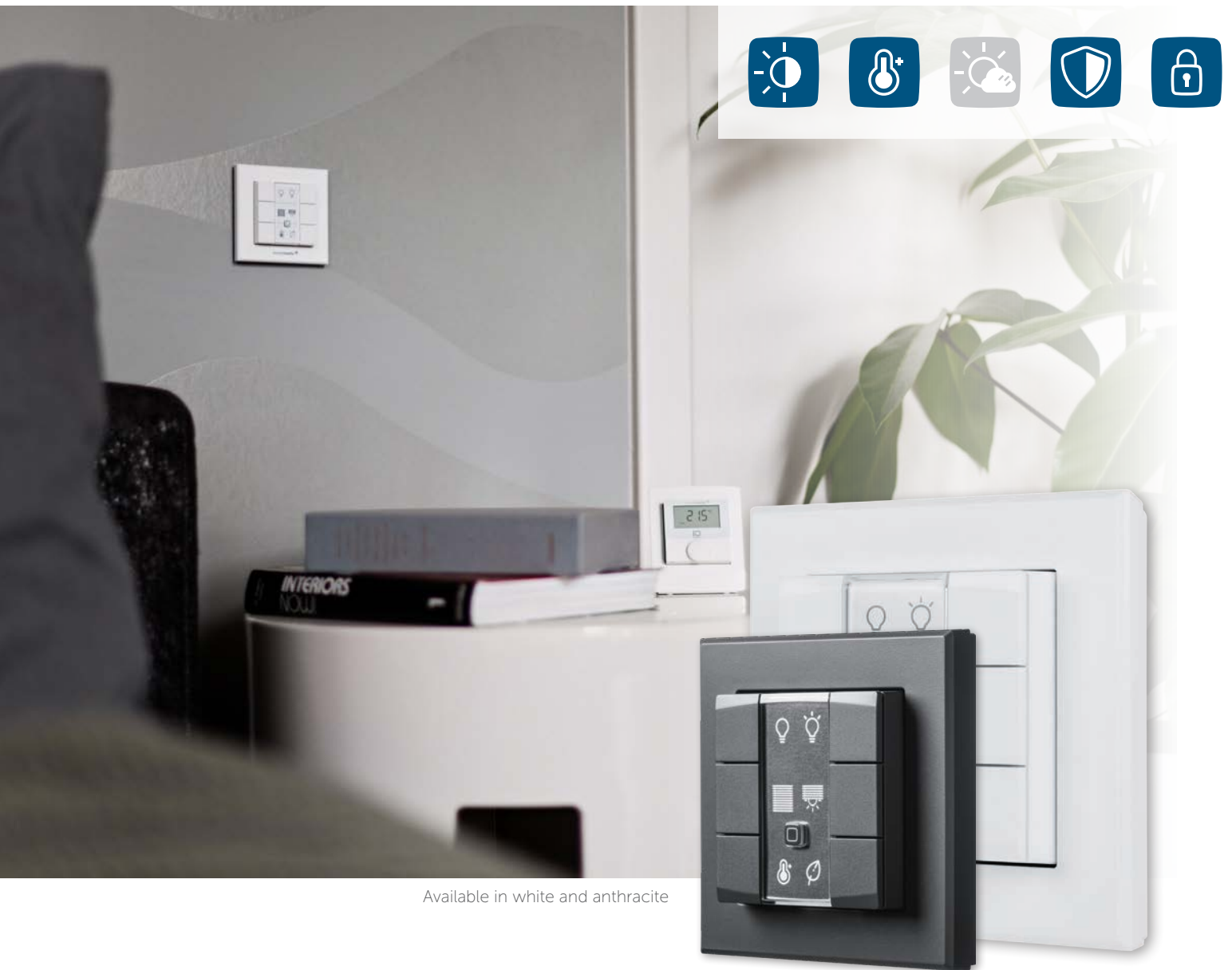

Available in white and anthracite

homematic 
Smart Living, Simply Exciting.

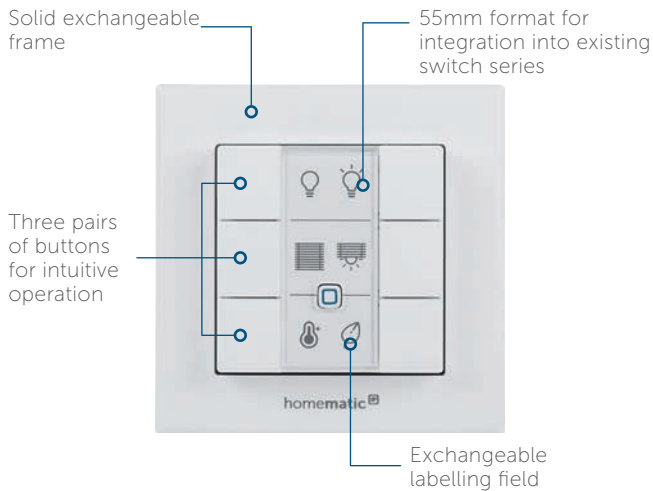

MODULAR DESIGN FOR HIGH FLEXIBILITY

Thanks to its modular design, the wall-mount remote control offers individual use:

- ✓ Adhesive or screw mounting in the supplied clip-on frame with enclosed mounting material
- ✓ Integration into existing switches with 55 mm frames of the the most common manufacturers
- ✓ Installation on a free flush-mounted box with corresponding mounting plate
- ✓ Integration into Homematic IP Desk Stand (HmIP-DS55) for increased battery lifetime
- ✓ As an alternative to battery operation, the wall-mount remote control can also be supplied with 230 V via the Homematic IP Power Supply Unit for brand switches (HmIP-BPS).

THE IDEAL FUNCTION FOR EACH APPLICATION

The six intuitive push-buttons offer comfortable control of several devices or system functions in your smart home at the touch of a button.

The device can be used to switch light sources on or off, activate or deactivate the eco mode or to move shutters up or down.

INDIVIDUAL FUNCTIONS

Thanks to the exchangeable labelling field for the individual buttons, the wall-mount remote control can be easily adapted to individual requirements and applications. You can use standard labelling fields with texts and symbols or free templates (various labelling templates are available at www.homematic-ip.com).

QUICK AND EASY INSTALLATION

Easy installation without any wiring effort thanks to battery operation and radio communication. The device can be placed where it is needed. It is ideal for mounting on walls, glass or furniture, for example – without the need to lay any power cables. Only the supplied adhesive strips or screws are required for installation. Thanks to residue-free removal of the adhesive strips, the wall-mount remote control is even suitable for rented property.

To enable operation, the device has to be connected with one of the following solutions:

- Homematic IP Access Point with free smartphone app and free cloud service
- Third-party solutions of partners

TECHNICAL SPECIFICATIONS

Supply voltage	2x 1.5 V LR03/micro/AAA
Battery life	4 years (typ.)
Degree of protection	IP20
Ambient temperature	5 to 35 °C
Dimensions (W x H x D)	
Without frame:	55 x 55 x 20 mm
Including frame:	86 x 86 x 22 mm
Weight	95 g (including batteries)
Radio frequency band	868.0-868.6 MHz 869.4-869.65 MHz
Typ. open area RF range	200 m

LOGISTICAL DATA

Version	White	Anthracite
Product reference	142308A0	159828A0
EAN code	4047976423088	4047976598281
Short description	HmIP-WRC6	HmIP-WRC6-A
Packing unit	90	90
Packing dimensions	122 x 112 x 48 mm	122 x 112 x 48 mm
Weight incl. packaging	182,0 g	182,0 g

PACKAGE CONTENTS

Homematic IP Wall-mount Remote Control – 6 buttons
 Labelling template
 Clip-on frame and mounting plate
 Mounting accessories
 1.5 V LR03/micro/AAA batteries (2x)
 User manual

Contact Interface flush-mount – 1 channels

HmIP-FCI1

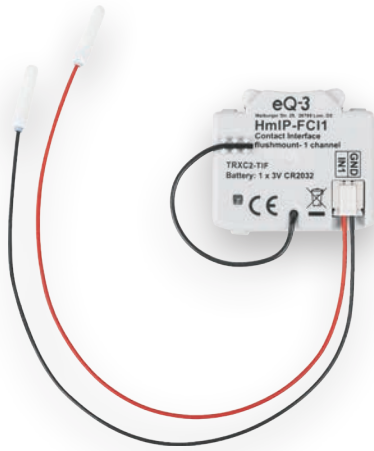

homematic IP
Smart living. Simply exciting.



The Homematic IP Contact Interface is easily integrated into the Homematic IP system for the convenient wireless control of other Homematic IP devices using conventional pushbuttons or switches. The very flat design and battery operation allow the Contact Interface to be easily installed in a flush-mounted box.

EASY TO RETROFIT

The Contact Interface allows retrofitting of elements such as conventional floating pushbuttons or switches to enable intelligent and individual wireless control.

Operation requires connection to one of the following solutions:

- Homematic IP access point with free smartphone app and free cloud service
- CCU3 central control unit with WebUI local user interface
- Third-party partner solutions

SMART INTEGRATION & UNIVERSAL USE

With the Contact Interface, any potential-free switches, pushbuttons or contacts can be easily integrated into the Homematic IP system, e.g. to implement the following functions:

- ✓ Switches: Switch lights on and off
- ✓ Pushbuttons: Dim lights or raise and lower shutters
- ✓ Contacts for monitoring windows and doors: Reduce temperature when ventilating, trigger an alarm, lock/unlock door lock drive

SIMPLE INSTALLATION

No mains connection is required thanks to the long-life lithium battery. The very flat design allows the contact Interface to be mounted directly behind the installed switch insert in standard flush-mounted boxes.

TECHNICAL SPECIFICATIONS

Supply voltage	1x 3 V CR2032
Battery life	2 years (typical)
Degree of protection	IP20
Ambient temperature	5 to 35 °C
Dimensions (W x H x D)	41 x 12 x 35 mm
Weight	14.5 g (including batteries)
Radio frequency band	868.0-868.6 MHz 869.4-869.65 MHz
Typical range in open space	280 m

LOGISTICS DATA

Product reference	153489A0
EAN code	4047976534890
Short description	HmIP-FCI1
Packing unit	144
Packing dimensions	122 x 93 x 36 mm
Weight incl. packaging	77.0 g

PACKAGE CONTENTS

Homematic IP Contact Interface flush-mount – 1 channel
Connecting cable
3 V CR2032 battery
Operating manual

Flush-Mounted Contact Interface – 6 channels

HmIP-FCI6



homematic IP
Smart living. Simply exciting.



The Homematic IP Contact Interface is easily integrated into the Homematic IP system for the convenient wireless control of other Homematic IP devices using conventional pushbuttons or switches. The very flat design and battery operation allow the contact interface to be easily installed in a flush-mounted box.

EASY TO RETROFIT

The Contact Interface allows retrofitting of elements such as conventional floating pushbuttons or switches with six buttons to enable intelligent and individual wireless control.

Operation requires connection to one of the following solutions:

- Homematic IP access point with free smartphone app and free cloud service
- CCU3 central control unit with WebUI local user interface
- Third-party partner solutions

TECHNICAL SPECIFICATIONS

Supply voltage	2x 1.5 V LR03/micro/AAA
Battery life	3 years (typical)
Degree of protection	IP20
Ambient temperature	5 to 35 °C
Dimensions (W x H x D)	48.5 x 53 x 15 mm
Weight	50 g (including batteries)
Radio frequency band	868.0-868.6 MHz 869.4-869.65 MHz
Typical range in open space	230 m
Connection length	3 m (per input)

SMART INTEGRATION & UNIVERSAL USE

With the Contact Interface, any potential-free switches, pushbuttons or contacts can be easily integrated into the Homematic IP system, e.g. to implement the following functions:

- ✓ Switches: Switch lights on and off
- ✓ Pushbuttons: Dim lights or raise and lower shutters
- ✓ Contacts for monitoring windows and doors: Reduce temperature when ventilating, trigger an alarm, lock/unlock door lock drive

SIMPLE INSTALLATION

No mains connection is required thanks to battery operation. The very flat design allows the Contact Interface to be installed in standard flush-mounted boxes - and in the case of deep boxes also behind an already installed switch insert.

LOGISTICS DATA

Product reference	153501A0
EAN code	4047976535019
Short description	HmIP-FCI6
Packing unit	144
Packing dimensions	122 x 93 x 36 mm
Weight incl. packaging	107.5 g

PACKAGE CONTENTS

Homematic IP Contact Interface flush-mount – 6 channel
Connecting cable
1.5 V LR03/Micro/AAA Batterien (2x)
Operating manual

THE COMPACT AND
RELIABLE
OUTDOOR SENSOR

Temperature and Humidity Sensor – outdoor

HmIP-STHO | HmIP-STHO-A

This temperature and humidity sensor reliably measures the outdoor temperature and humidity. So your smart home can react quickly and automatically to changes in the weather. And you will always have an overview via the Homematic IP app.



Also available in anthracite

homematic ^{IP}
Smart living. Simply exciting.

Available in white and anthracite



RELIABLE TEMPERATURE MEASUREMENT

The Homematic IP Temperature and Humidity Sensor measures the temperature and humidity in outdoor areas. The measured values are transferred cyclically to the Homematic IP access point as well as to the Homematic IP app.

KEEPING AN EYE ON AIR TEMPERATURE

You can learn the current humidity and outdoor temperature with a glance at the Homematic IP app. The temperature fluctuations that are especially common in spring and autumn can be detected and, for example, pipe heaters switched on automatically or push notifications sent.

To enable operation, the device must be connected with one of the following solutions:

- Homematic IP Access Point with free smartphone app and free cloud service
- Third-party partner solutions

TECHNICAL SPECIFICATIONS

Supply voltage	2x 1.5 V LR06/Mignon/AA
Battery life	5 years (typical)
Degree of protection	IP44
Ambient temperature	-20 to 55 °C
Measuring range temperature	-20 to +55 °C
Measuring range humidity	0 to 99 %
Dimensions (W x H x D)	59 x 82 x 41 mm
Weight	100 g (including batteries)
Radio frequency band	868.0-868.6 MHz 869.4-869.65 MHz
Typical radio free-field range	220 m
Humidity accuracy (typically)	± 3 % (in a range of 20 and 80 %)
Temperature accuracy (typically)	± 0.3 °C (in a range of 5 to 60 °C)

PRACTICAL HUMIDITY WARNING

Used with a Homematic IP Wall Thermostat or indoor temperature and humidity sensor (e.g. HmIP-WTH, HmIP-STH), the difference in humidity between outdoor and indoor use is measured and evaluated. This means that a recommendation to ventilate can be sent at any time via the Homematic IP app, or as a push message on your smartphone, and mould growth can be prevented, for example.

EASY TO RETROFIT

Thanks to its radio communication and battery operation, the device is highly flexible as far as selecting a mounting location is concerned.

Mounting and removal are particularly easy using the screws and plugs supplied.

RUGGED HOUSING ENSURES HIGH FLEXIBILITY

Thanks to its robust and weatherproof housing, the thermostat can be fixed in almost any mounting position:

- ✓ Freely positionable thanks to its weatherproof housing with protection class IP44
- ✓ Particularly durable thanks to 5-year battery life
- ✓ Available in white (HmIP-STHO) and anthracite (HmIP-STHO-A)
- ✓ For even greater convenience, it can be combined with Homematic IP Wall Thermostats or indoor temperature and humidity sensors (e.g. HmIP-STH, HmIP-STDH, HmIP-WTH, etc.)

LOGISTICS DATA

Version	White	Anthracite
Product reference	150573A0	150574A0
EAN code	4047976505739	4047976505746
Short description	HmIP-STHO	HmIP-STHO-A
Packing unit	90	90
Packing dimensions	122 x 112 x 48 mm	122 x 112 x 48 mm
Weight incl. packaging	179.8 g	179.8 g

PACKAGE CONTENTS

Homematic IP Temperature and Humidity Sensor – outdoor
Screws (2x) and plugs (2x)
1.5 V LR6/Mignon/AA batteries (2x)
Operating manual

REACT DYNAMICALLY
TO CHANGING LIGHT
CONDITIONS

Light Sensor – outdoor

HmIP-SLO

The light sensor reliably measures brightness in the outdoor area of the smart home. When used with other Homematic IP devices, the light sensor can be employed for many different purposes, such as switching on lights or extending the awning.



homematic ^{IP}
Smart living. Simply exciting.



To enable operation, the device must be connected with one of the following solutions:

- Homematic IP Access Point with free smartphone app and free cloud service
- Third-party partner solutions

PRECISE, RELIABLE LIGHT MEASUREMENT

The Homematic IP Light Sensor measures brightness (in lux) and is suitable for outdoor areas. The measured values are transferred cyclically to the Homematic IP access point as well as to the Homematic IP app.

SMART COMMUNICATION

Various functions in the smart home can be intelligently controlled via the smart outdoor light sensor. At dusk, for example, lights can be switched on and shutters lowered. And in strong sunshine the awning can be automatically extended.

INDOOR SHADE WHEN NEEDED

In strong sunshine, the roller shutters or blinds can be automatically lowered to prevent the living areas from overheating.

PERSONALISED CHOICE OF INSTALLATION LOCATION

Thanks to the radio communication and battery operation, the light sensor is highly flexible as far as selecting a mounting location is concerned. Mounting is particularly easy using the screws and plugs supplied. The light sensor can also be used as a standing unit.

IDEAL FOR OUTDOOR USE

Thanks to its particularly rugged (temperature range -20 to +55 °C) and weatherproof housing with protection class IP43, the sensor can be mounted in almost any position.

TECHNICAL SPECIFICATIONS

Supply voltage	2x 1.5 V LR6/Mignon/AA
Battery life	3 years (typical)
Degree of protection	IP43
Ambient temperature	-20 to +55 °C
Dimensions (W x H x D)	52 x 65 x 34 mm
Weight	100 g (including batteries)
Radio frequency band	868.0-868.6 MHz 869.4-869.65 MHz
Typical radio free-field range	310 m
Measuring range brightness	0.01 to 83860 lx
Measuring accuracy brightness	±10 %, ±0.1 lx

LOGISTICS DATA

Product reference	151566A0
EAN code	4047976515660
Short description	HmlP-SLO
Packing unit	90
Packing dimensions	122 x 112 x 48 mm
Weight incl. packaging	183.0 g

PACKAGE CONTENTS

Homematic IP Light Sensor – outdoor
Screws (2x) and plugs (2x)
1.5 V LR6/Mignon/AA batteries (2x)
Operating manual

ADAPTS YOUR SMART
HOME TO THE
CURRENT WEATHER
CONDITIONS

Weather Sensor – basic

HmlIP-SWO-B

The Homematic IP Weather Sensor – basic is the entry-level version of the weather sensors from Homematic IP. Equipped with the essential sensors, the device reliably and accurately records the current weather conditions and offers numerous application options within the Homematic IP system.

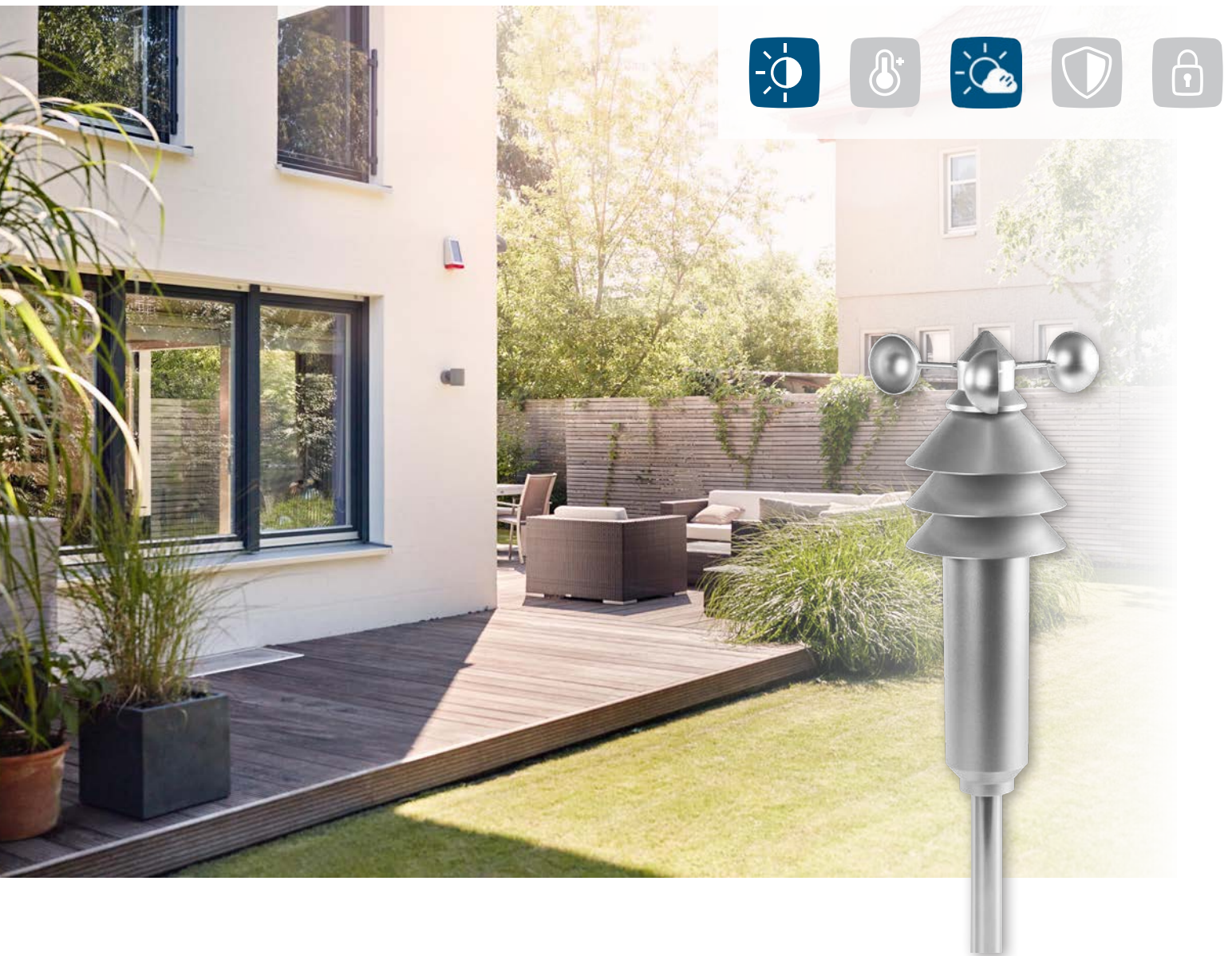

homematic ^{IP}
Smart living. Simply exciting.

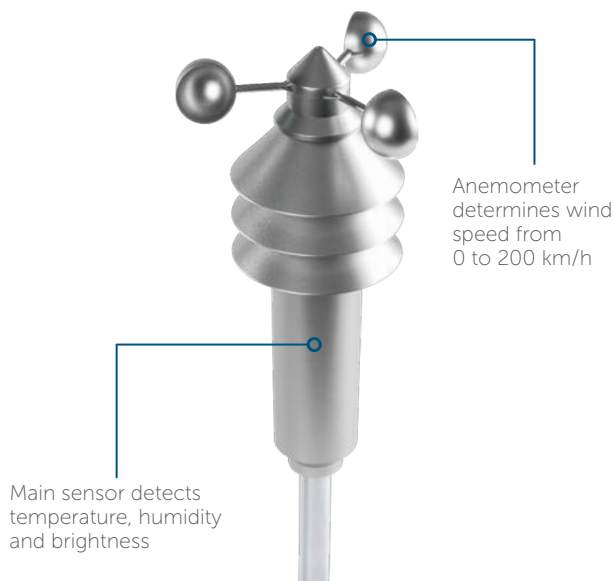

DISPLAYS CURRENT WEATHER DATA

The following weather data is recorded:

- ✓ temperature
- ✓ humidity
- ✓ wind speed
- ✓ brightness
- ✓ sunshine duration

The data collected is displayed in the Homematic IP app. This means you always know what the current weather situation is at home, even when you are on the move.

FLEXIBLE AND ROBUST

Radio communication and battery operation mean that the weather sensor is easy to install with flexible positioning. And it has a radio range of up to 400 m in free field. The robust stainless steel ground spike ensures secure anchoring in the ground. Alternatively, the device can also be mounted on a pole using clamps. This allows the weather sensor to be positioned wherever you need to precisely determine the current weather situation and, for example, immediately protect the awning in high winds.

WIDE RANGE OF APPLICATIONS

Combined with other Homematic IP devices, the weather sensor makes daily life easier: within a storm protection device, the shutters can be lowered automatically when a user-defined wind speed is detected. Just one way the weather sensor provides additional protection for a smart home.

SMART ADD-ONS

The rain sensor and the light sensor from Homematic IP are ideal add-ons to the weather sensor to immediately protect the awning when it starts to rain or to automatically lower the roller shutters in strong sunlight.



HOMEMATIC IP WEATHER SENSOR COMPARISON TABLE

	basic	plus	pro
Temperature	✓	✓	✓
Humidity	✓	✓	✓
Wind speed	✓	✓	✓
Wind direction	-	-	✓
Brightness	✓	✓	✓
Sunshine duration	✓	✓	✓
Rain onset	-	✓	✓
Rainfall	-	✓	✓

To enable operation, the device must be connected with one of the following solutions:

- Homematic IP Access Point with free smartphone app and free cloud service
- Third-party partner solutions

TECHNICAL SPECIFICATIONS

Supply voltage	3x 1.5 V LR6/Mignon/AA
Battery life	2 years (typical)
Measuring ranges	
Temperature	-20 to +55 °C
Humidity (relative)	1 to 99 %
Brightness (relative)	0 to 10.000
Wind speed	0 to 200 km/h
Dimensions (W x H x D)	15 x 42 x 15 cm (not incl. mast)
Dimensions stainless steel mast (h x ø)	1.58 m x 25 mm
Weight	463 g (including batteries)
Radio frequency band	868.0-868.6 MHz 869.4-869.65 MHz
Typical open area RF range	400 m

LOGISTICS DATA

Product reference	152056A0
EAN code	4047976520565
Short description	HmIP-SWO-B
Packing unit	4
Packing dimensions	564 x 184 x 147 mm
Weight incl. packaging	1986.3 g

PACKAGE CONTENTS

Homematic IP Weather Sensor – basic
 Stainless steel mast
 Tube connector, hose clamp and tube connector profile
 Screwdriver (hexagon socket head)
 1.5 V LR6/Mignon/AA batteries (3x)
 Operating manual

ADAPTS YOUR SMART
HOME TO THE
CURRENT WEATHER
CONDITIONS

Weather Sensor – plus

HmlIP-SWO-PL

The Homematic IP Weather Sensor – plus is the extended version of the weather sensors from Homematic IP. With its large number of sensors, the device reliably and accurately records the current weather situation and offers extensive application options within the Homematic IP system.



homematic ^{IP}
Smart living. Simply exciting.

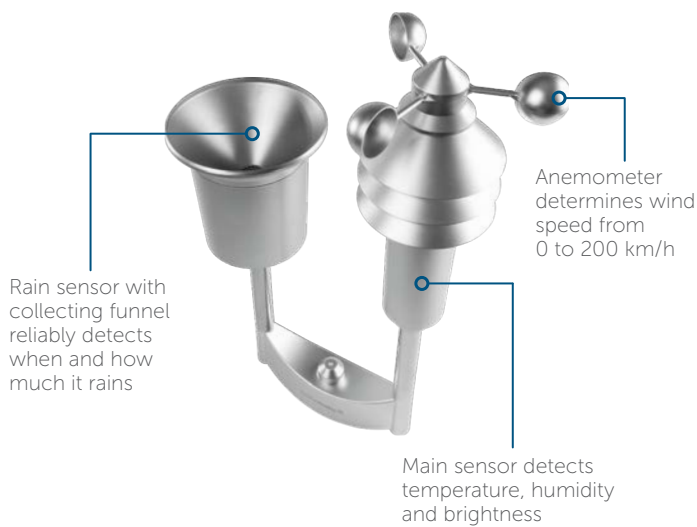

HOMEMATIC IP WEATHER SENSOR COMPARISON TABLE

	basic	plus	pro
Temperature	✓	✓	✓
Humidity	✓	✓	✓
Wind speed	✓	✓	✓
Wind direction	-	-	✓
Brightness	✓	✓	✓
Sunshine duration	✓	✓	✓
Rain onset	-	✓	✓
Rainfall	-	✓	✓

To enable operation, the device must be connected with one of the following solutions:

- Homematic IP Access Point with free smartphone app and free cloud service
- Third-party partner solutions

TECHNICAL SPECIFICATIONS

Supply voltage	3x 1.5 V LR6/Mignon/AA
Battery life	2 years (typical)
Measuring ranges	
Temperature	-20 to +55 °C
Humidity (relative)	1 to 99 %
Brightness (relative)	0 to 10.000
Rainfall	0 to 966 mm
Wind speed	0 to 200 km/h
Dimensions (W x H x D)	35 x 53 x 15 cm (not incl. mast)
Dimensions stainless steel mast (h x ø)	1.58 m x 25 mm
Weight	1064 g (including batteries)
Radio frequency band	868.0-868.6 MHz 869.4-869.65 MHz
Typical open area RF range	400 m

DISPLAYS CURRENT WEATHER DATA

The following weather data is recorded:

- ✓ temperature
- ✓ humidity
- ✓ wind speed
- ✓ brightness
- ✓ rainfall/onset
- ✓ sunshine duration

The data collected is displayed in the Homematic IP app. This means you always know what the current weather situation is at home, even when you are on the move.

FLEXIBLE AND ROBUST

Radio communication and battery operation mean that the weather sensor is easy to install with flexible positioning. And it has a radio range of up to 400 m in free field. The robust stainless steel ground spike ensures secure anchoring in the ground. Alternatively, the device can also be mounted on a pole using clamps. This allows the weather sensor to be positioned wherever you need to precisely determine the current weather situation and, for example, immediately protect the awning in high winds.

WIDE RANGE OF APPLICATIONS

Combined with other Homematic IP devices, the weather sensor makes daily life easier: within a storm protection device, the shutters can be lowered automatically when a user-defined wind speed is detected. Just one way the weather sensor provides additional protection for a smart home.

SMART ADD-ONS

The rain sensor and the light sensor from Homematic IP are ideal add-ons to the weather sensor to immediately protect the awning when it starts to rain or to automatically lower the roller shutters in strong sunlight.



LOGISTICS DATA

Product reference	152057A0
EAN code	4047976520572
Short description	HmIP-SWO-PL
Packing unit	2
Packing dimensions	564 x 369 x 147 mm
Weight incl. packaging	2871.4 g

PACKAGE CONTENTS

Homematic IP Weather Sensor – plus
Stainless steel mast
Screws (2x)
Screwdriver (hexagon socket head)
1.5 V LR6/Mignon/AA batteries (3x)
Operating manual

ADAPTS YOUR SMART
HOME TO THE
CURRENT WEATHER
CONDITIONS

Weather Sensor – pro

HmIP-SWO-PR

The Homematic IP Weather Sensor – pro is the perfect outdoor add-on to a smart home. Numerous sensors reliably and accurately detect the current weather conditions and enable a wide range of functions in the Homematic IP system to be automatically triggered.



homematic ^{IP}
Smart living. Simply exciting.



HOMEMATIC IP WEATHER SENSOR COMPARISON TABLE

	basic	plus	pro
Temperature	✓	✓	✓
Humidity	✓	✓	✓
Wind speed	✓	✓	✓
Wind direction	-	-	✓
Brightness	✓	✓	✓
Sunshine duration	✓	✓	✓
Rain onset	-	✓	✓
Rainfall	-	✓	✓

To enable operation, the device must be connected with one of the following solutions:

- Homematic IP Access Point with free smartphone app and free cloud service
- Third-party partner solutions

TECHNICAL SPECIFICATIONS

Supply voltage	3x 1.5 V LR6/Mignon/AA
Battery life	2 years (typical)
Measuring ranges	
Temperature	-20 to +55 °C
Humidity (relative)	1 to 99 %
Brightness (relative)	0 to 10.000
Rainfall	0 to 966 mm
Wind speed	0 to 200 km/h
Dimensions (W x H x D)	35 x 53 x 15 cm (not incl. mast)
Dimensions stainless steel mast (h x ø)	1.58 m x 25 mm
Weight	1064 g (including batteries)
Radio frequency band	868.0-868.6 MHz 869.4-869.65 MHz
Typical open area RF range	400 m

DISPLAYS CURRENT WEATHER DATA

The following weather data is recorded:

- ✓ temperature
- ✓ humidity
- ✓ wind direction
- ✓ wind speed
- ✓ brightness
- ✓ rainfall/onset
- ✓ sunshine duration

The data collected is displayed in the Homematic IP app. This means you always know what the current weather situation is at home, even when you are on the move.

FLEXIBLE AND ROBUST

Radio communication and battery operation enable the weather sensor to be easily installed and flexibly positioned. And it has a radio range of up to 400 m in free field. The robust stainless steel ground spike ensures secure anchoring in the ground. Alternatively, the device can also be mounted on a pole using standard clamps. This allows the weather sensor to be positioned wherever you need to precisely determine the current weather situation and, for example, immediately protect the awning in high winds.

WIDE RANGE OF APPLICATIONS

Combined with other Homematic IP devices, the weather sensor makes daily life easier: within a storm protection device, the shutters can be lowered automatically when a user-defined wind speed is detected. Just one way the weather sensor provides additional protection for a smart home.

SMART ADD-ONS

The rain sensor and the light sensor from Homematic IP are ideal add-ons to the weather sensor to immediately protect the awning when it starts to rain or to automatically lower the roller shutters in strong sunlight.



LOGISTICS DATA

Product reference	151821A0
EAN code	4047976518210
Short description	HmlIP-SWO-PR
Packing unit	2
Packing dimensions	564 x 369 x 147 mm
Weight incl. packaging	3676.0 g

PACKAGE CONTENTS

Homematic IP Weather Sensor – pro
Stainless steel mast
Screws (2x)
Screwdriver (hexagon socket head)
1.5 V LR6/Mignon/AA batteries (3x)
Operating manual

FEELS EVERY
CHANGE

Tilt and Vibration Sensor

HmIP-STV

The compact sensor detects changes in position or vibrations and can perform many tasks in your Smart Home. The reliable monitoring, of garage doors, windows or letter box flaps, for example, ensures more comfort and security.

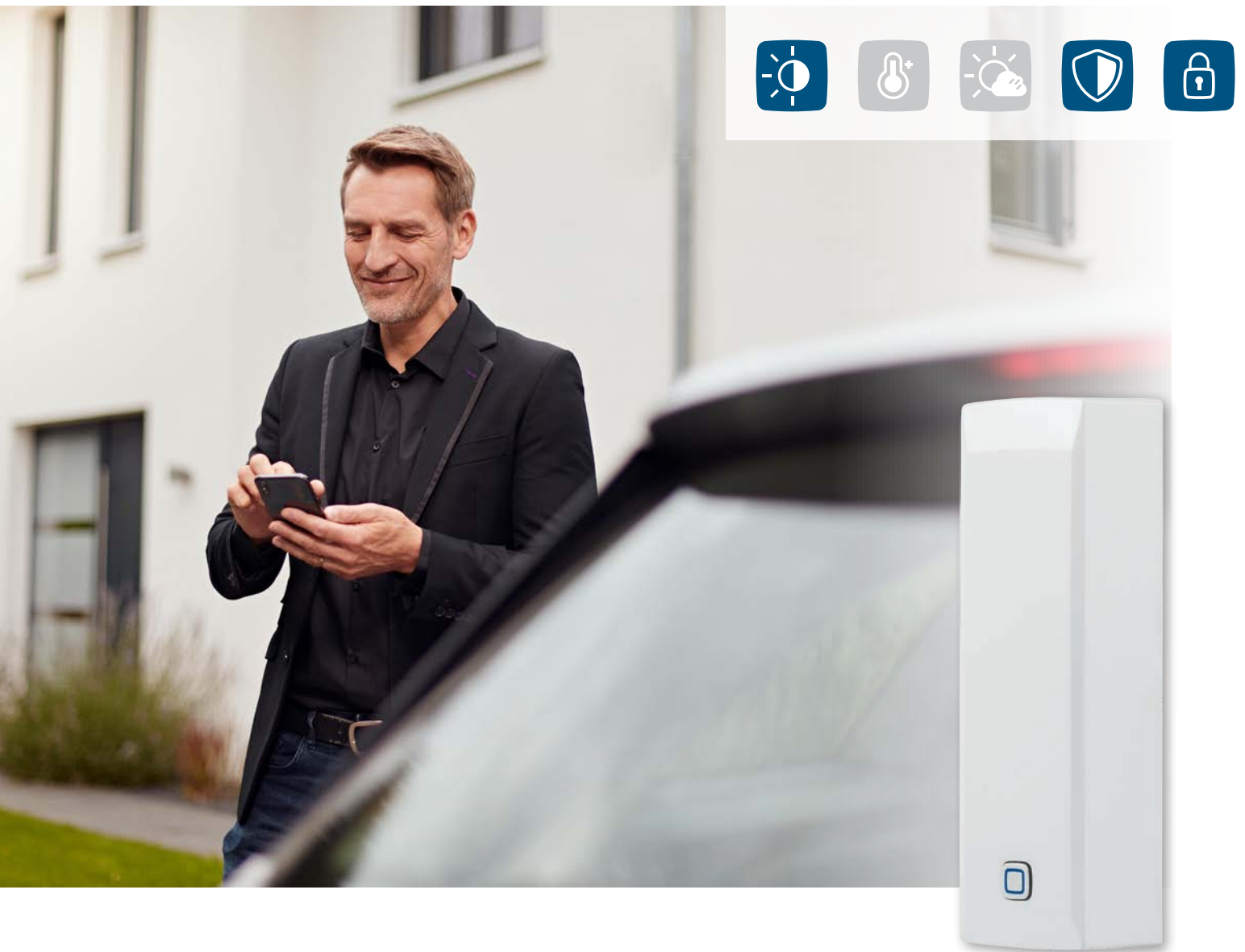

homematic ^{IP}

Smart living. Simply exciting.



Application example:
Garage door

Operation requires connection to one of the following solutions:

- Homematic IP access point with free smartphone app and free cloud service
- Third-party partner solutions

TECHNICAL SPECIFICATIONS

Supply voltage	2x 1.5 V LR03/micro/AAA
Battery life	2 years (typical)
Degree of protection	IP30
Ambient temperature	-20 to +55 °C
Dimensions (W x H x D)	25 x 85 x 20 mm
Weight	50 g (including batteries)
Radio frequency band	868.0-868.6 MHz 869.4-869.65 MHz
Typical range in open space	250 m

MANY POSSIBLE USES FOR MORE COMFORT AND SECURITY

Configurable as position or vibration sensors:

- ✓ Recognises changes in position in an angle from 10 to 45° and monitors moving objects, such as garage doors or cellar opening covers.
- ✓ Reports vibrations at the assembly position or at windows.

HIGHLY SENSITIVE SENSOR

Records even the smallest vibrations at the installation location and reports them immediately to the Homematic IP System. The sensitivity of the sensor can be adjusted individually for the intended use concerned.

ALL THE INFORMATION AT A GLANCE

The Homematic IP app enables an overview of all of the objects to be monitored – in this way, any actions (e.g., switching on the garage light) can be triggered by status and position changes in the Smart Home and accessed easily at any time, even when you're on the move.

COMPACT HOUSING

The sensor is ideal for use in indoor rooms, but can also be used in weatherproof outdoor locations. Thanks to the compact design, the sensor can also be used in positions where space is tight.

SIMPLY GLUE OR SCREW

Very little installation work thanks to battery operation and radio communication. The installation material included in the delivery scope allows the sensor to be fixed with screws or quickly and easily with adhesive strips.

LOGISTICS DATA

Product reference	151979A0
EAN code	4047976519798
Short description	HmlIP-STV
Packing unit	90
Packing dimensions	122 x 112 x 48 mm
Weight incl. packaging	143.5 g

PACKAGE CONTENTS

Homematic IP Tilt and Vibration Sensor
Double-sided adhesive strips (2x) and screws (2x)
1.5 V LR03/Micro/AAA batteries (2x)
Operating manual